



**Pakhtunkhwa Energy Development Organization
(PEDO)
Government of Khyber Pakhtunkhwa (KP)**

**BIDDING DOCUMENTS
FOR
CONSTRUCTION OF PROTECTION EMBANKMENT
UPSTREAM OF POWERHOUSE – RANOLIA HPP**

CONTRACT NO: RHPP/PEDO/RRW-01/PE-01

Bidding Documents

May 2023



SUMMARY OF CONTENTS

<u>Subject</u>	<u>Page No</u>
(I) INVITATION FOR BIDS	1
(II) INSTRUCTIONS TO BIDDERS & BIDDING DATA	3-16
(III) FORM OF BID & SCHEDULES TO BID	17-36
(IV) CONDITIONS OF CONTRACT & CONTRACT DATA	37-54
(V) STANDARD FORMS	55-63
(VI) SPECIFICATIONS	64-67
(VII) DRAWINGS	68

INVITATION FOR BIDS



INVITATION FOR BIDS**Date: 15.06.2023**

1. Pakhtunkhwa Energy Development Organization (PEDO), Peshawar invites sealed bids through Single Stage One Envelope Bidding Procedure under the KPPRA Rules 2014 as amended, for the following Works from eligible firms licensed by the Pakistan Engineering Council in the appropriate category i-e C-5 and above duly registered with Khyber Pakhtunkhwa Revenue Authority (KPPRA).

S. No	Name of Work	Estimated Cost in million (Rs.)	Bid Security (Rs.)	Period of Completion	Last Date for submission of Bids	Date of Opening of Bids and Time	Required Category of PEC
1	Construction of Protection Embankment upstream of Powerhouse at Ranolia Hydropower Project (RHPP), District Lower Kohistan, KP	44.20	900,000	180 days	15.06.2023 1100 hours	15.06.2023 1130 hours	C-5 and Above

2. Bidding Documents can be downloaded up to one day prior from PEDO website: www.pedo.pk and the same are also available on KPPRA and Energy & Power Department's websites. The cost of bidding Documents (Rs. 2,000/-) in the form of deposit at call from a scheduled bank of Pakistan will be submitted at the time of bid submission to PEDO.
3. Bidding shall be done on above / below / at par system on BOQ/Engineer's estimate based on MRS 2022.
4. All bidders are required to be on active status with KPPRA and having valid PEC registration in the relevant category.
5. The bidders shall submit through courier/ By hand the bidding documents along photo copy of CNIC and PEC registration.
6. The bidder shall, along with bidding documents, submit the bid security (Rs. 900,000) in the form of bank guarantee from a scheduled bank of Pakistan.
7. The bidders quoting their bids more than 10% below upto 20% below on Engineers' Estimate shall submit along with their bids 8% Additional Security of Engineer's Estimated cost in addition to 2% bid security. If the bid is not accompanied with the required amount of additional security then the said bid will be dealt as per KPPRA Notification: S.R.O. (14)/Vol: 1-24/2021-22: dated May 10, 2022.
8. In case of more than 20% below bids, if the bid is not accompanied by the detailed rate analysis and / or required amount of additional security, then the said bid will be dealt as per KPPRA Notification: S.R.O. (14)/Vol: 1-24/2021-22: dated May 10, 2022.
9. In case detailed rate analysis submitted with the bids is, in view of the Procuring Entity, not convincing, the Head of the Procuring Entity may declare such bid as per KPPRA Notification: S.R.O. (14)/Vol: 1-24/2021-22: dated May 10, 2022.
10. Pre-bid meeting shall be held on Thursday June 08, 2023 11:00 am, PEDO House Peshawar.

Director (M&E)/Focal Person (RHPP)
 PEDO House, 1st Floor, Room No. 222,
 Sector B/2, Phase V, Hayatabad, Peshawar,
 Islamic Republic of Pakistan
 Tel: 0919217004, Fax: 0919217340

**INSTRUCTIONS TO BIDDERS
&
BIDDING DATA**



TABLE OF CONTENTS
INSTRUCTIONS TO BIDDERS

<i>Clause No.</i>	<i>Description</i>	<i>Page No.</i>
A. GENERAL		5
IB.1	Scope of Bid & Source of Funds	
IB.2	Eligible Bidders	
IB.3	Cost of Bidding	
B. BIDDING DOCUMENTS		5
IB.4	Contents of Bidding Documents	
IB.5	Clarification of Bidding Documents	
IB.6	Amendment of Bidding Documents	
C. PREPARATION OF BID		7
IB.7	Language of Bid	
IB.8	Documents Comprising the Bid	
IB.9	Sufficiency of Bid	
IB.10	Bid Prices, Currency of Bid & Payment	
IB.11	Documents Establishing Bidder's Eligibility and Qualifications	
IB.12	Documents Establishing Works' Conformity to Bidding Documents	
IB.13	Bidding Security	
IB.14	Validity of Bids, Format, Signing and Submission of Bid	
D. SUBMISSION OF BID		9
IB.15	Deadline for Submission, Modification & Withdrawal of Bids	
E. BID OPENING AND EVALUATION		10
IB.16	Bid Opening, Clarification and Evaluation	
IB.17	Process to be Confidential	
F. AWARD OF CONTRACT		12
IB.18	Qualification	
IB.19	Award Criteria & Employers Right	
IB.20	Notification of Award & Signing of Contract Agreement	
IB.21	Performance Security	
IB.22	Integrity Pact	

INSTRUCTIONS TO BIDDERS

(Note: These Instructions to Bidders (IB) along with Bidding Data will not be part of Contract and will cease to have effect once the Contract is signed).

A. GENERAL

IB.1 Scope of Bid & Source of Funds

1.1 Scope of Bid

The Procuring Entity as defined in the Bidding Data (hereinafter called “the Employer”) wishes to receive Bids for the Works summarized in the Bidding Data (hereinafter referred to as “the Works”).

Bidders must quote for the complete scope of work. Any Bid covering partial scope of work will be rejected as non-responsive.

1.2 Source of Funds

The Procuring Entity has arranged funds from its own sources. [or any other source which may be indicated accordingly]

IB.2 Eligible Bidders

2.1 Bidding is open to all firms and persons meeting the following requirements:

- a) duly licensed by the Pakistan Engineering Council (PEC) in the appropriate category for value of Works (if applicable)
- b) duly registered with KPRA having active status at the time of bid submission.

IB.3 Cost of Bidding-

3.1 The bidder shall bear all costs including bid solicitation documents fee (nominal so as to cover printing/reproduction and mailing costs) and other costs associated with the preparation and submission of its bid and the Procuring Entity will in no case be responsible or liable for those costs, regardless of the conduct or outcome of the bidding process.

B. BIDDING DOCUMENTS

IB.4 Contents of Bidding Documents

4.1 In addition to Invitation for Bids, the Bidding Documents are those stated below, and should be read in conjunction with any Addendum issued in accordance with Sub-Clause IB.6.1.

1. Instructions to Bidders & Bidding Data
2. Form of Bid & Schedules to Bid Schedules to Bid comprise the following:
 - (i) Schedule A: Schedule of Prices
 - (ii) Schedule B: Specific Works Data
 - (iii) Schedule C: Works to be Performed by Subcontractors
 - (iv) Schedule D: Proposed Program of Works
 - (v) Schedule E: Method of Performing Works
 - (vi) Schedule F: Integrity Pact
3. Conditions of Contract & Contract Data
4. Standard Forms:
 - (i) Form of Bid Security
 - (ii) Form of Performance Security
 - (iii) Form of Contract Agreement
 - (iv) Form of Bank Guarantee for Advance Payment
5. Specifications
6. Drawings, if any

IB.5 Clarification of Bidding Documents

- 5.1 A prospective bidder requiring any clarification(s) in respect of the Bidding Documents may notify the Engineer/Procuring Entity at the Procuring Entity's/Engineer's address indicated in the Bidding Data.
- 5.2 The Engineer/Procuring Entity will respond to any request for clarification which it receives earlier than seven (7) days prior to the deadline for the submission of Bids. Copies of the Engineer/Procuring Entity's response will be forwarded to all prospective bidders, at least five (5) days prior to dead line for submission of Bids, who have received the Bidding Documents including a description of the enquiry but without identifying its source.

IB.6 Amendment of Bidding Documents

- 6.1 At any time prior to the deadline for submission of Bids, the Procuring Entity may, for any reason, whether at his own initiative or in response to a clarification requested by a prospective bidder, modify the Bidding Documents by issuing addendum.
- 6.2 Any addendum thus issued shall be part of the Bidding Documents pursuant to Sub-Clause 6.1 hereof, and shall be communicated in writing to all purchasers of the Bidding Documents. Prospective bidders shall acknowledge receipt of each addendum in writing to the Procuring Entity.
- 6.3 To afford prospective bidders reasonable time in which to take an addendum into account in preparing their Bids, the Procuring Entity may at its discretion extend the deadline for submission of Bids.

PREPARATION OF BIDS

IB.7 Language of Bid

- 7.1 The bid prepared by the bidder and all correspondence and documents relating to the Bid, exchanged by the bidder and the Procuring Entity shall be written in the English language, provided that any printed literature furnished by the bidder may be written in another language so long as accompanied by an English translation of its pertinent passages in which case, for purposes of interpretation of the Bid, the English translation shall govern.

IB.8 Documents Comprising the Bid

- 8.1 The bid prepared by the bidder shall comprise the following components:
- (a) Covering Letter
 - (b) Form of Bid duly filled, signed and sealed, in accordance with Sub-Clause IB.14.3.
 - (c) Schedules (A to F) to Bid duly filled and initialed, in accordance with the instructions contained therein & in accordance with Sub-Clause IB14.3.
 - (d) Bid Security furnished in accordance with Clause IB.13 as well as bid solicitation documents fee as per Clause IB 3.1.
 - (e) Power of Attorney in accordance with Sub-Clause IB 14.5.
 - (f) Documentary evidence in accordance with Clause IB.11
 - (g) Documentary evidence in accordance with Clause IB.12.

IB.9 Sufficiency of Bid

- 9.1 Each bidder shall satisfy himself before bidding as to the correctness and sufficiency of his Bid and of the rates and prices entered in the Schedule of Prices, which rates and prices shall except in so far as it is otherwise expressly provided in the Contract, cover all his obligations under the Contract and all matters and things necessary for the proper completion of the Works
- 9.2 The bidder is advised to obtain for himself at his own cost and responsibility all information that may be necessary for preparing the bid and entering into a Contract for execution of the Works.

IB.10 Bid Prices, Currency of Bid and Payment

- 10.1 The bidder shall fill up the Schedule of Prices (Schedule A to Bid) indicating the unit rates and prices of the Works to be performed under the Contract. Unit rate offered for an item shall be considered upto two significant decimal places for evaluation purposes by the Procuring Entity. Prices in the Schedule of Prices shall be entered keeping in view the instructions contained in the Preamble to Schedule of Prices.
- 10.2 Unless otherwise stipulated in the Conditions of Contract, prices quoted by the bidder

shall remain fixed during the bidder's performance of the Contract and not subject to variation on any account.

- 10.3 The unit rates and prices in the Schedule of Prices shall be quoted by the bidder in the currency as stipulated in Bidding Data.

IB.11 Documents Establishing Bidder's Eligibility and Qualifications

- 11.1 Pursuant to Clause IB.8, the bidder shall furnish, as part of its bid, documents establishing the bidder's eligibility to bid and its qualifications to perform the Contract if its bid is accepted.
- 11.2 Bidder/Manufacturer must possess and provide evidence of its capability and the experience as stipulated in Bidding Data and the Qualification Criteria stipulated in the Bidding Documents.

IB.12 Documents Establishing Works' Conformity to Bidding Documents

- 12.1 The documentary evidence of the Works' conformity to the Bidding Documents may be in the form of literature, drawings and data and the bidder shall furnish documentation as set out in Bidding Data.
- 12.2 The bidder shall note that standards for workmanship, material and equipment and references to brand names or catalogue numbers if any, designated by the Procuring Entity in the Technical Provisions are intended to be descriptive only and not restrictive.

IB.13 Bid Security

- 13.1 Each bidder shall furnish, as part of his bid, at the option of the bidder, a Bid Security in the amount stipulated in Bidding Data in Pak. Rupees in the form of Deposit at Call [Deleted]¹ or a Bank Guarantee issued by a Scheduled Bank in Pakistan in favour of the Procuring Entity valid for a period up to twenty eight (28) days beyond the bid validity date. [The bid security shall be submitted from the account of the firm/bidder/contractor who submits the bid]²
- 13.2 Any bid not accompanied by an acceptable Bid Security shall be rejected by the Procuring Entity as non-responsive.
- 13.3 The bid securities of unsuccessful bidders will be returned upon award of contract to the successful bidder or on the expiry of validity of Bid Security whichever is earlier.
- 13.4 ["The bid security of successful bidder be retained with the Procuring Entity till completion of the defect liability period and the amount of guarantee will be reduced by an equivalent amount".]³

¹ The words “/ Pay Order” is deleted vide KPPRA Notification No. KPPRA/M&E/Estt:/1-12/2017-18 dated April 05, 2018.

² Inserted by KPPRA Notification No. KPPRA/M&E/Estt:/1-12/2017-18 dated April 05, 2018.

³ Substituted by KPPRA Notification No. KPPRA/M&E/Estt:/1-4/2016 dated May 24, 2016.

- 13.5 The Bid Security may be forfeited:

- (a) if a bidder withdraws his bid during the period of bid validity; or
- (b) if a bidder does not accept the correction of his Bid Price, pursuant to Sub-Clause 16.4 (b) hereof; or
- (c) in the case of a successful bidder, if he fails to:
 - (i) furnish the required Performance Security in accordance with Clause IB.21, or
 - (ii) sign the Contract Agreement, in accordance with Sub-Clauses IB.20.2 & 20.3.

IB.14 Validity of Bids, Format, Signing and Submission of Bid

- 14.1 Bids shall remain valid for the period stipulated in the Bidding Data after the date of bid opening.
- 14.2 All Schedules to Bid are to be properly completed and signed.
- 14.3 No alteration is to be made in the Form of Bid except in filling up the blanks as directed. If any alteration be made or if these instructions be not fully complied with, the bid may be rejected.
- 14.4 Each bidder shall prepare Original and number of copies specified in the Bidding Data of the documents comprising the bid as described in Clause IB.8 and clearly mark them "ORIGINAL" and "COPY" as appropriate. In the event of discrepancy between them, the original shall prevail.
- 14.5 The original and all copies of the bid shall be typed or written in indelible ink and shall be signed by a person or persons duly authorized to sign (in the case of copies, Photostats are also acceptable). This shall be indicated by submitting a written Power of Attorney authorizing the signatory of the bidder to act for and on behalf of the bidder. All pages of the bid shall be initialed and official seal be affixed by the person or persons signing the bid.
- 14.6 The Bid shall be delivered in person, through courier service or sent by registered mail, or as specifically instructed by the Procuring Entity otherwise, at the address to Procuring Entity as given in Bidding Data.

C. SUBMISSION OF BID

IB.15 Deadline for Submission, Modification & Withdrawal of Bids

- 15.1 Bids must be received by the Procuring Entity at the address/provided in Bidding Data not later than the time and date stipulated therein. In the event of the specified date for the submission of bids declared a holiday for the Employer, the Bids will be received up to the appointed time on the next working day.
- 15.2 Bids submitted through telegraph, telex, fax or e-mail shall not be considered.

- 15.3 Any bid received by the Procuring Entity after the deadline for submission prescribed in Bidding Data will be returned unopened to such bidder.
- 15.4 Any bidder may modify or withdraw his bid after bid submission provided that the modification or written notice of withdrawal is received by the Procuring Entity prior to the deadline for submission of bids.
- 15.5 Withdrawal of a bid during the interval between the deadline for submission of bids and the expiration of the period of bid validity specified in the Form of Bid may result in forfeiture of the Bid Security pursuant to Sub-Clause IB.13.5 (a).

D. BID OPENING AND EVALUATION

IB.16 Bid Opening, Clarification and Evaluation

- 16.1 The Procuring Entity will open the bids, in the presence of bidders' representatives who choose to attend, at the time, date and location stipulated in the Bidding Data.
- 16.2 The bidder's name, Bid Prices, any discount, the presence or absence of Bid Security, and such other details as the Procuring Entity at its discretion may consider appropriate, will be announced by the Procuring Entity at the bid opening. The Procuring Entity will record the minutes of the bid opening. Representatives of the bidders who choose to attend shall sign the attendance sheet.

Any Bid Price or discount which is not read out and recorded at bid opening will not be taken into account in the evaluation of bid.

- 16.3 To assist in the examination, evaluation and comparison of Bids the Engineer/Procuring Entity may, at its discretion, ask the bidder for a clarification of its Bid. The request for clarification and the response shall be in writing and no change in the price or substance of the Bid shall be sought, offered or permitted.
- 16.4 (a) Prior to the detailed evaluation, pursuant to Sub-Clauses IB.16.7 to 16.9, the Engineer/Procuring Entity will determine the substantial responsiveness of each bid to the Bidding Documents. For purpose of these Clauses, a substantially responsive bid is one which conforms to all the terms and conditions of the Bidding Documents without material deviations. It will include to determine the requirements listed in Bidding Data.
- (b) Arithmetical errors will be rectified on the following basis:

If there is a discrepancy between the unit price and total price that is obtained by multiplying the unit price and quantity, the unit price shall prevail and the total price shall be corrected. If there is a discrepancy between the words and figures the amount in words shall prevail. If there is a discrepancy between the Total Bid price entered in Form of Bid and the total shown in Schedule of Prices-Summary, the amount stated in the Form of Bid will be corrected by the Procuring Entity in accordance with the Corrected Schedule of Prices.

If the bidder does not accept the corrected amount of Bid, his Bid will be rejected



and his Bid Security forfeited.

- 16.5 A Bid determined as substantially non-responsive will be rejected and will not subsequently be made responsive by the bidder by correction of the non-conformity.
- 16.6 Any minor informality or non-conformity or irregularity in a Bid which does not constitute a material deviation may be waived by Procuring Entity, provided such waiver does not prejudice or affect the relative ranking of any other bidders.
- 16.7 The Engineer/Procuring Entity will evaluate and compare only the bids previously determined to be substantially responsive pursuant to Sub-Clauses IB.16.4 to 16.6 as per requirements given hereunder. Bids will be evaluated for complete scope of works. The prices will be compared on the basis of the Evaluated Bid Price pursuant to Sub-Clause 16.8 herein below.

(a) Technical Evaluation

It will be examined in detail whether the Works offered by the bidder complies with the Technical Provisions of the Bidding Documents. For this purpose, the bidder's data submitted with the bid in Schedule B to Bid will be compared with technical features/criteria of the Works detailed in the Technical Provisions. Other technical information submitted with the bid regarding the Scope of Work will also be reviewed.

(b) Financial Evaluation

It will be examined in detail whether the bids comply with the commercial/contractual conditions of the Bidding Documents. It is expected that no material deviation/stipulation shall be taken by the bidders.

16.8 Evaluated Bid Price

In evaluating the bids, the Engineer/Procuring Entity will determine for each bid in addition to the Bid Price, the following factors (adjustments) in the manner and to the extent indicated below to determine the Evaluated Bid Price:

- (i) making any correction for arithmetic errors pursuant to Sub-Clause 16.4 hereof.
- (ii) making an appropriate price adjustment for any other acceptable variation or deviation.
- (iii) making an appropriate price adjustment for deviations in terms of Payments (if any and acceptable to the Procuring Entity).
- (iv) discount, if any, offered by the bidders as also read out and recorded at the time of bid opening.

16.9 Evaluation Methods

Pursuant to Sub-Clause 16.8, Para (ii), and (iii) following evaluation methods for price adjustments will be followed:

- (i) Price Adjustment for Technical Compliance

The cost of making good any deficiency resulting from technical non-compliance will be added to the Corrected Total Bid Price for comparison purposes only. The adjustments will be applied taking the highest price quoted by other bidders being evaluated in detail in their original Bids for corresponding item. In case of non-availability of price from other bidders, the price will be estimated by the Engineer/Procuring Entity.

(ii) Price Adjustment for Commercial Compliance

The cost of making good any deficiency resulting from any quantifiable variations and deviations from the Bid Schedules and Conditions of Contract, as determined by the Engineer/Procuring Entity will be added to the Corrected Total Bid Price for comparison purpose only. Adjustment for commercial compliance will be added to the Corrected Total Bid Prices.

(iii) Price Adjustment for Deviation in Terms of Payments Refer to Bidding Data

IB.17 Process to be Confidential

- 17.1 Subject to Sub-Clause IB.16.3 heretofore, no bidder shall contact Engineer/Procuring Entity on any matter relating to its Bid from the time of the Bid opening to the time the bid evaluation result is announced by the Procuring Entity. The evaluation result shall be announced at least ten (10) days prior to award of Contract. The announcement to all bidders will include table(s) comprising read out prices, discounted prices, price adjustments made, final evaluated prices and recommendations against all the bids evaluated.
- 17.2 Any effort by a bidder to influence Engineer/Procuring Entity in the Bid evaluation, Bid comparison or Contract Award decisions may result in the rejection of his Bid. Whereas, any bidder feeling aggrieved may lodge a written complaint not later than fifteen (15) days after the announcement of the bid evaluation result, however, mere fact of lodging a complaint shall not warrant suspension of procurement process.

E. AWARD OF CONTRACT

IB.18. Post Qualification

- 18.1 The Procuring Entity, at any stage of the bid evaluation, having credible reasons for or *prima facie* evidence of any defect in supplier's or contractor's capacities, may require the suppliers or contractors to provide information concerning their professional, technical, financial, legal or managerial competence whether already pre-qualified or not:

Provided that such qualification shall only be laid down after recording reasons therefor in writing. They shall form part of the records of that bid evaluation report.

- 18.2 The determination will take into account the bidder's financial and technical capabilities. It will be based upon an examination of the documentary evidence of the bidders' qualifications submitted under Clause IB.11, as well as such other information required in the Bidding Documents.

IB.19 Award Criteria & Procuring Entity's Right

- 19.1 Subject to Sub-Clause IB.19.2, the Procuring Entity will award the Contract to the bidder whose bid has been determined to be substantially responsive to the Bidding Documents and who has offered the lowest evaluated Bid Price, provided that such bidder has been determined to be qualified to satisfactorily perform the Contract in accordance with the provisions of Clause IB.18.
- 19.2 Notwithstanding Sub-Clause IB.19.1, the Procuring Entity reserves the right to accept or reject any bid, and to annul the bidding process and reject all bids, at any time prior to award of Contract (acceptance of a bid or proposal rule 47(1), without thereby incurring any liability to the affected bidders or any obligation to inform the affected bidders of the grounds for the Procuring Entity's action except that the grounds for its rejection of all bids shall upon request be communicated, to any bidder who submitted a bid, without justification of the grounds. Notice of the rejection of all the bids shall be given promptly to all the bidders.

IB.20 Notification of Award & Signing of Contract Agreement

- 20.1 Prior to expiration of the period of bid validity prescribed by the Procuring Entity, the Procuring Entity will notify the successful bidder in writing ("Letter of Acceptance") that his bid has been accepted.
- 20.2 Within seven (7) days from the date of furnishing of acceptable Performance Security under the Conditions of Contract, the Procuring Entity will send the successful bidder the Form of Contract Agreement provided in the Bidding Documents, incorporating all agreements between the parties.
- 20.3 The formal Agreement between the Procuring Entity and the successful bidder shall be executed within seven (7) days of the receipt of Form of Contract Agreement by the successful bidder from the Procuring Entity.

IB.21 Performance Security

- 21.1 The successful bidder shall furnish to the Procuring Entity a Performance Security in the form and the amount stipulated in the Conditions of Contract within a period of fourteen (14) days after the receipt of Letter of Acceptance.
- 21.2 Failure of the successful bidder to comply with the requirements of Sub-Clauses IB.20.2 & 20.3 or 21.1 or Clause IB.22 shall constitute sufficient grounds for the annulment of the award and forfeiture of the Bid Security.

IB.22 Integrity Pact

The Bidder shall sign and stamp the Form of Integrity Pact provided at Schedule-F to Bid in the Bidding Document for all procurement contracts exceeding Rupees ten (10) million. Failure to provide such Integrity Pact shall make the bid non-responsive.

BIDDING DATA

Instructions to Bidders

Clause Reference

1.1 Name of Procuring Entity

Pakhtunkhwa Energy Development Organization (PEDO), Government of Khyber Pakhtunkhwa Province.

Brief Description of Works: Construction of Protection Embankment upstream of Powerhouse – Ranolia HPP

The Scope of Work to be carried out under this contract comprise construction of about 225m Protection Embankment along Dubair Khwar upstream and in front of the Powerhouse, complete in all respects as per drawings and specifications. The Works shall also involve excavation, riprap, mass concrete, compacted fill and boulders fill, etc. as specified.

2.1 (c) Add the following after 2.1 (b)

All the partners of the JV must also be registered with FBR and KPRA at the time of submission of bid. The successful JV must also be on Active Tax Payer list (ATL) of FBR and KPRA prior to the signing of the Contract Agreement.

5.1 (a) Procuring Entity's address:

Director (M&E)/Focal Person (RHPP)
PEDO House, 1st Floor, Room No. 222,
Sector B/2, Phase V, Hayatabad, Peshawar,
Islamic Republic of Pakistan
Tel: 0919217004
Fax: 0919217340

(b) Engineer's address:

AGES Consultants
57-E, Canal Road, University Town,
Peshawar.

10.1 Delete the text from “*indicating the unit ratesupto two decimal places*” and replace by the following:

After the total amount shown on Bill No 1 Work Items of Schedule of Prices under Schedule – A to Bid, the bidder shall enter the amount as percent Above / Below of the above amount of Work Item.

10.3 Bid shall be quoted entirely in Pak. Rupees. The payment shall be made in Pak. Rupees.

11.2 The bidder/manufacturer has the financial, technical and production capability necessary to perform the Contract as follows:

- The Bidder should be licensed by the PEC in category C-5 or above and having financial soundness as per PEC requirements for the relevant category.
- The Bidder should be an Active Filer with the relevant tax authorities. (KPRA and FBR) Copy of Audit Report / Balance Sheets and Income Tax Return statements for the last three (03) years must be attached.
- The Bidder should have executed at least three (3) specific projects of similar size and nature, including construction of Protection / Embankment / flood protection works, worth Rs.35 million during the last 5 years
- The Bidder should have at least ten (10) years' general experience in construction of civil works with minimum of 5 projects at least of Rs. 15 million and above

12.1 (a) Following documents must be attached;

- Copy of the valid PEC License;
 - Evidence that the bidder is on Active Tax Payer List of KPRA on bid submission date
 - Copies of letters of acceptance and completion/substantial completion certificates, duly attested by the Employer, showing sufficient description of the Works previously executed by the Bidders.
- (b) Complete set of technical information, description data, literature and drawings as required in accordance with Schedule B to Bid, Specific Works Data. This will include but not be limited to a sufficient number of drawings, photographs, catalogues, illustrations and such other information as is necessary to illustrate clearly the significant characteristics such as general construction dimensions and other relevant information about the works to be performed.
- (c) Technical Specifications notified by the GoKP- MRS 2022 are applicable.

13.1 **Amount of Bid Security**

Rs. 900,000 (Pak Rupees Nine Hundred Thousand)

Bid Security shall be in the form of Bank Guarantee from a Schedule Bank of Pakistan or from a foreign bank duly counter guaranteed by a Scheduled Bank in favour of the Procuring Entity

14.1 **Period of Bid Validity**

Ninety (90) days

14.4 **Number of Copies of the Bid to be Submitted**

One original plus Two (2) copies

14.6 (a) Procuring Entity's Address for the Purpose of Bid Submission

PEDO House, 1st Floor, Room No. 222
Sector B/2, Phase V, Hayatabad, Peshawar,
Islamic Republic of Pakistan

15.1 Deadline for Submission of Bids

1100 hours on June 15, 2023

16.1 Venue, Time, and Date of Bid Opening

Venue: Committee Room of the PEDO House,
Sector B/2, Phase V, Hayatabad, Peshawar
Time: 1130 hours (Local Time)
Date: June 15, 2023

16.4 Substantial Responsiveness of Bids

- (i) the Bid is valid till required period,
- (ii) the Bid prices are firm during currency of contract,
- (iii) completion period offered is within specified limits,
- (iv) the Bidder/Manufacturer is eligible to Bid and possesses the requisite experience, capability and qualification.
- (v) The bid is accompanied by the requisite bid security.
- (vi) the Bid does not deviate from basic technical requirements and
- (vii) the Bids are generally in order, etc.

16.9 Price Adjustment:

- (iii) Price Adjustment for Deviations in Terms of Payment

If a bid deviates from the terms of payment/payment conditions as specified in the Conditions of Contract and if such deviation is considered acceptable to the Procuring Entity, mark-up earned for any earlier payments involved in the terms outlined in the Bid as compared to those stipulated in the Conditions of Contract shall be calculated at the mark-up rate eight percent (8%) per annum and shall be added to the Corrected Total Bid Price for comparison purposes only.

**FORM OF BID
AND
SCHEDULES TO BID**



FORM OF BID

Bid Reference No. RHPC/PEDO/RRW-01/PE-01

Name of Work: Construction of Protection Embankment upstream of Powerhouse – Ranolia HPP

To:

Gentlemen,

1. Having examined the Bidding Documents including Instructions to Bidders, Bidding Data, Conditions of Contract, Contract Data, Specifications, Drawings, if any, Schedule of Prices and Addenda Nos. _____ for the execution of the above-named Works, we, the undersigned, being a company doing business under the name of _____ and address _____ and being duly incorporated under the laws of Pakistan hereby offer to execute and complete such Works and remedy any defects therein in conformity with the said Documents including Addenda thereto for the Total Bid Price of Rs _____ (Rupees _____) or such other sum as may be ascertained in accordance with the said Documents.
2. We understand that all the Schedules attached hereto form part of this Bid.
3. As security for due performance of the undertakings and obligations of this Bid, we submit herewith a Bid Security in the amount of Rs 900,000/- (Rupees nine hundred thousand only) drawn in your favour or made payable to you and drawn in your favour or made payable to you and valid for a period of twenty eight (28) days beyond the period of validity of Bid.
4. We undertake, if our Bid is accepted, to commence the Works and to deliver and complete the Works comprised in the Contract within the time(s) stated in Contract Data.
5. We agree to abide by this Bid for the period of 90 days from the date fixed for receiving the same and it shall remain binding upon us and may be accepted at any time before the expiration of that period.
6. Unless and until a formal Agreement is prepared and executed, this Bid, together with your written acceptance thereof, shall constitute a binding contract between us.
7. We undertake, if our Bid is accepted, to execute the Performance Security referred to in Conditions of Contract for the due performance of the Contract.
8. We understand that you are not bound to accept the lowest or any bid you may receive.

9. We do hereby declare that the Bid is made without any collusion, comparison of figures or arrangement with any other person or persons making a bid for the Works.

Dated this _____ day of _____, 2023

Signature _____

in the capacity of _____ duly authorized to sign bid for and on behalf of

(Name of Bidder in Block Capitals)

(Seal)

Address:

Witness:

(Signature) _____

Name: _____ NIC No. _____

Address: _____



SCHEDULES TO BID INCLUDE THE FOLLOWING:

- Schedule A to Bid: Schedule of Prices
- Schedule B to Bid: Specific Works Data
- Schedule C to Bid: Works to be Performed by Subcontractors
- Schedule D to Bid: Proposed Program of Works
- Schedule E to Bid: Method of Performing Works
- Schedule F to Bid: Integrity Pact



SCHEDULE – A TO BID

SCHEDULE OF PRICES

S. No.		Page
1.	Preamble to Schedule of Prices	22
2.	Schedule of Prices	24
	(a) Summary of Bid Prices	
	(b) Detailed Schedule of Prices	

SCHEDULE - A TO BID

PREAMBLE TO SCHEDULE OF PRICES

1. General

- 1.1 The Schedule of Prices shall be read in conjunction with the Conditions of Contract, Contract Data together with the Specifications and Drawings, if any.
- 1.2 The Contract shall be for the whole of the Works as described in these Bidding Documents. Bids must be for the complete scope of works.

2. Description

- 2.1 The general directions and descriptions of works and materials are not necessarily repeated nor summarized in the Schedule of Prices. References to the relevant sections of the Bidding Documents shall be made before entering prices against each item in the Schedule of Prices.

3. Units & Abbreviations

- 3.1 Units of measurement, symbols and abbreviations expressed in the Bidding Documents shall comply with the Systeme Internationale d'Unites (SI Units).

4. Rates and Prices

- 4.1 Except as otherwise expressly provided under the Conditions of Contract, the rates and amounts entered in the Schedule of Prices shall be the rates at which the Contractor shall be paid and shall be the full inclusive value of the works set forth or implied in the Contract; except for the amounts reimbursable, if any to the Contractor under the Contract.
- 4.2 Unless otherwise stipulated in the Contract Data, the rates and prices entered by the bidder shall not be subject to adjustment during the performance of the Contract.
- 4.3 All duties, taxes and other levies payable by the Contractor shall be included in the rates and prices.
- 4.4 The whole cost of complying with the provisions of the Contract shall be included in the items provided in the Schedule of Prices, and where no items are provided, the cost shall be deemed to be distributed among the rates and prices entered for the related items of the Works and no separate payment will be made for those items.

The rates, prices and amounts shall be entered against each item in the Schedule of Prices. Any item against which no rate or price is entered by the bidder will not be paid for by the Procuring Entity when executed and shall be deemed covered by the rates and prices for other items in the



Schedule of Prices.

- 4.5 (a) The bidder shall be deemed to have obtained all information as to and all requirements related thereto which may affect the bid price.
- (b) The Contractor shall be responsible to make complete arrangements for the transportation of the Manpower, Plant, Equipment and Materials etc. to the Site.
- 4.6 The Contractor shall provide for all parts of the Works to be completed in every respect. Notwithstanding that any details, accessories, etc. required for the complete installation and satisfactory operation of the Works, are not specifically mentioned in the Specifications, such details shall be considered as included in the Contract Price

5. Bid Prices

5.1 Break-up of Bid Prices

The various elements of Bid Prices shall be quoted as detailed by the Procuring Entity in the format of Schedule of Prices.

The bidder shall recognize such elements of the costs (including but not limited to the formwork etc. and all other associated costs,) which he expects to incur in the performance of the Works and shall include all such costs in the rates and amounts entered in the Schedule of Prices.

5.2 Total Bid Price

The total of bid prices in the Schedule of Prices shall be entered in the Summary of Bid Prices.

6. Provisional Sums

- 6.1 Provisional Sums included and so designated in the Schedule of Prices if any, shall be expended in whole or in part at the direction and discretion of the Engineer/Procuring Entity. The Contractor will only receive payment in respect of Provisional Sums if he has been instructed by the Engineer/Procuring Entity to utilize such sums.



SCHEDULE – A TO BID**SCHEDULE OF PRICES – SUMMARY OF BID PRICES**

Bill No.	Description	Total Amount (Rs)
1	Work Items – Construction of Protection Embankment upstream of Powerhouse (Carried from Bill No. 1)	
2	Provisional Sum (Carried from Bill No. 2)	4,500,000
Total Bid Price (The amount to be entered in Paragraph 1 of the Form of Bid) (In words)		

* The Total Bid Price quoted above to be entered in Paragraph 1 of the Form of Bid as well.

SCHEDULE – A TO BID**SCHEDULE OF PRICES****BILL NO. 1 WORK ITEMS**

Item Ref:	DESCRIPTION	UNIT	Qty	Rate (PKR)	Amount (PKR)
03-11-a	Excavation in shingle or gravel formation & rock not requiring blast, undressed, 50m lead : Dry	m ³	21,159	319.12	6,752,133
03-11-b	Excavation in shingle or gravel formation & rock not requiring blast, undressed, 50m lead : Wet	m ³	14,106	425.44	6,001,092
03-19-b-i	Transportation for every 15 m extra lead or part thereof for gravel, shingle or rock (beyond 50m upto 65m)	m ³	3,986	7.93	31,625
03-19-b-ii	Transportation for every 15 m extra lead or part thereof for gravel, shingle or rock (beyond 65m upto 80m)	m ³	7,972	15.87	126,499
03-19-b-iii	Transportation for every 15 m extra lead or part thereof for gravel, shingle or rock (beyond 80m upto 95m)	m ³	9,300	23.80	221,373
03-19-b-iv	Transportation for every 15 m extra lead or part thereof for gravel, shingle or rock (beyond 95m upto 110m)	m ³	5,314	31.74	168,665
03-06-b	Embankment formation in ordinary soil & compaction by mechanical means at optimum moistures content to 90% max. modified AASHTO dry density (borrow area).	m ³	229	519.86	118,866
03-29-b	Compaction of earth with power road roller 90% max. mod. AASHTO dry density	m ³	13,903	268.03	3,726,385
19-35	Collect & stack boulders from nullah beds or loose shale etc. within 100m lead	m ³	1,688	1202.93	2,030,828
10-57-c	Rip Rap, Class C	m ³	2,751	4608.24	12,677,316
06-44-c	PCC 1:3:6 in mass concrete less formwork using 30% boulders	m ³	1,096	9813.77	10,751,247
06-47-b	Erection and removal of Formwork with Steel Surface Finshing for RCC or Plain cement Concrete in any shape - Position / Vertical	m ²	876	1018.69	892,804
03-69	Filter Layer of Granular Material	m ³	332	2114.31	702,741
				Total	44,201,575
	Amount as % of Above (Above / Below/at par				
	Total Amount Bill No.1 (to be carried to Summary of Bid Price				

BILL NO. 2 – PROVISIONAL SUMS

Item Ref:	DESCRIPTION	UNIT	Qty	Rate (PKR)	Amount (PKR)
Para 6 of Preamble to Schedule of Prices	Provisional Sum	LS	1	4,500,000	4,500,000
Total Amount Bill No. 2 (to be carried to Summary of Bid Price)					4,500,000



SCHEDULE - B TO BID

SPECIFIC WORKS DATA

The main technical data is prescribed in the relevant Sections of the Technical Specifications of Market Rate Analysis (MRS) Year 2022, prepared by the GoKP for development projects and repair / maintenance works.

The Bidder is required to provide evidence of the five (5) projects of similar size and nature. However, the Bidder may supplement the main technical data by providing other salient parameters, if any.



SCHEDULE – C TO BID

WORKS TO BE PERFORMED BY SUBCONTRACTORS

Not Applicable

SCHEDULE – D TO BID

PROPOSED PROGRAM OF WORKS

Bidder shall provide a program in a bar-chart showing the sequence of work items by which he proposes to complete the Works of the entire Contract. The program should indicate the sequence of work items and the period of time during which he proposes to complete the Works.



SCHEDULE – E TO BID

METHOD OF PERFORMING WORKS

The bidder is required to submit a narrative outlining the method of performing the Works. The narrative should indicate in detail and include but not be limited to:

- The sequence and methods in which he proposes to carry out the Works.
- A list of all major items of constructional and erectional plant, tools and vehicles proposed to be used in delivering/carrying out the Works at Site
- Organization chart indicating field office personnel involved in execution / supervision of the Works to be done under the Contract.

SCHEDULE – F TO BID

(INTEGRITY PACT)

**DECLARATION OF FEES, COMMISSION AND BROKERAGE ETC. PAID BY
THE SUPPLIERS OF GOODS, SERVICES & WORKS IN CONTRACTS
WORTH RS. 10.00 MILLION OR MORE**

Contract No. _____ Dated: _____
Contract Value: _____
Contract Title: _____

..... [name of the Bidder] hereby declares that it has not obtained or induced the procurement of any contract, right, interest, privilege or other obligation or benefit from Government of Khyber Pakhtunkhwa or any administrative subdivision or agency thereof or any other entity owned or controlled by Government of Khyber Pakhtunkhwa through any corrupt business practice.

Without limiting the generality of the foregoing, [name of the Bidder] represents and warrants that it has fully declared the brokerage, commission, fees etc. paid or payable to anyone and not given or agreed to give and shall not give or agree to give to anyone within or outside Pakistan either directly or indirectly through any natural or juridical person, including its affiliate, agent, associate, broker, consultant, director, promoter, shareholder, sponsor or subsidiary, any commission, gratification, bribe, finder’s fee or kickback, whether described as consultation fee or otherwise, with the object of obtaining or inducing the procurement of a contract, right, interest, privilege or other obligation or benefit in whatsoever form from Government of Khyber Pakhtunkhwa , except that which has been expressly declared pursuant hereto.

[name of the Bidder] certifies that it has made and will make full disclosure of all agreements and arrangements with all persons in respect of or related to the transaction with GoKP and has not taken any action or will not take any action to circumvent the above declaration, representation or warranty.

[name of the Bidder] accepts full responsibility and strict liability for making any false declaration, not making full disclosure, misrepresenting facts or taking any action likely to defeat the purpose of this declaration, representation and warranty. It agrees that any contract, right, interest, privilege or other obligation or benefit obtained or procured as aforesaid shall, without prejudice to any other rights and remedies available to GoKP under any law, contract or other instrument, be voidable at the option of GoKP.

Notwithstanding any rights and remedies exercised by GoKP in this regard, [name of the Bidder] agrees to indemnify GoKP for any loss or damage incurred by it on account of its corrupt business practices and further pay compensation to GoKP in an amount equivalent to ten time the sum of any commission, gratification, bribe, finder’s fee or kickback given by [name of the Bidder] as aforesaid for the purpose of obtaining or inducing the procurement of any contract, right, interest, privilege or other obligation or benefit in whatsoever form from GoKP.

Name of the Procuring Entity: Name of the Bidder:
Signature: Signature:
[Seal] [Seal]

**CONDITIONS OF CONTRACT &
CONTRACT DATA**



TABLE OF CONTENTS**CONDITIONS OF CONTRACT**

<i>Clause No.</i>	<i>Description</i>	<i>Page No.</i>
1.	GENERAL PROVISIONS.....	34
2.	THE PROCURING ENTITY.....	36
3.	ENGINEER'S/PROCURING ENTITY'S REPRESENTATIVES.....	36
4.	THE CONTRACTOR.....	37
5.	DESIGN BY CONTRACTOR.....	37
6.	PROCURING ENTITY'S RISKS	38
7.	TIME FOR COMPLETION.....	39
8.	TAKING-OVER	39
9.	REMEDYING DEFECTS.....	40
10.	VARIATIONS AND CLAIMS.....	40
11.	CONTRACT PRICE AND PAYMENT	41
12.	DEFAULT.....	43
13.	RISKS AND RESPONSIBILITIES	44
14.	INSURANCE.....	44
15.	RESOLUTION OF DISPUTES	45
16.	INTEGRITY PACT	46

CONDITIONS OF CONTRACT

1. GENERAL PROVISIONS

1.1 Definitions

In the Contract as defined below, the words and expressions defined shall have the following meanings assigned to them, except where the context requires otherwise:

The Contract

- 1.1.1 “Contract” means the Contract Agreement and the other documents listed in the Contract Data.
- 1.1.2 “Specifications” means the document as listed in the Contract Data, including Procuring Entity’s requirements in respect of design to be carried out by the Contractor (if any), and any Variation to such document.
- 1.1.3 “Drawings” means the Procuring Entity’s drawings of the Works as listed in the Contract Data, and any Variation to such drawings.

Persons

- 1.1.4 “Procuring Entity” means the person named in the Contract Data and the legal successors in title to this person, but not (except with the consent of the Contractor) any assignee.
- 1.1.5 “Contractor” means the person named in the Contract Data and the legal successors in title to this person, but not (except with the consent of the Procuring Entity) any assignee.
- 1.1.6 “Party” means either the Procuring Entity or the Contractor.

Dates, Times and Periods

- 1.1.7 “Commencement Date” means the date fourteen (14) days after the date the Contract comes into effect or any other date named in the Contract Data.
- 1.1.8 “Day” means a calendar day
- 1.1.9 “Time for Completion” means the time for completing the Works as stated in the Contract Data (or as extended under Sub-Clause 7.3), calculated from the Commencement Date.

Money and Payments

- 1.1.10 “Cost” means all expenditure properly incurred (or to be incurred) by the Contractor, whether on or off the Site, including overheads and similar charges but does not include any allowance for profit.

Other Definitions

- 1.1.11 “Contractor’s Equipment” means all machinery, apparatus and other things required for the execution of the Works but does not include Materials or Plant intended to form part of the Works.
- 1.1.12 “Country” means the Islamic Republic of Pakistan.
- 1.1.13 “Province” means Khyber Pakhtunkhwa.
- 1.1.14 “Procuring Entity’s Risks” means those matters listed in Sub-Clause 6.1.
- 1.1.14 “Force Majeure” means an event or circumstance which makes performance of a Party’s obligations illegal or impracticable and which is beyond that Party’s reasonable control.
- 1.1.15 “Materials” means things of all kinds (other than Plant) to be supplied and incorporated in the Works by the Contractor.
- 1.1.16 “Plant” means the machinery and apparatus intended to form or forming part of the Works.
- 1.1.17 “Site” means the places provided by the Procuring Entity where the Works are to be executed, and any other places specified in the Contract as forming part of the Site.
- 1.1.18 “Variation” means a change which is instructed by the Engineer/Procuring Entity under Sub-Clause 10.1.
- 1.1.19 “Works” means any or all the works whether Supply, Installation, Construction etc. and design (if any) to be performed by the Contractor including temporary works and any variation thereof.
- 1.1.20 “Engineer” means the person, if any, notified by the Procuring Entity to act as Engineer for the purpose of the Contract and named as such in Contract Data.

1.2 Interpretation

Words importing persons or parties shall include firms and organizations. Words importing singular or one gender shall include plural or the other gender where the context requires.

1.3 Priority of Documents

The documents forming the Contract are to be taken as mutually explanatory of one another. If an ambiguity or discrepancy is found in the documents, the priority of the documents shall be in accordance with the order as listed in the Contract Data.

1.4 Law

The law of the Contract is the relevant Law of Khyber Pakhtunkhwa Province,

1.5 Communications

All Communications related to the Contract shall be in English language.

1.6 Statutory Obligations

The Contractor shall comply with the Laws of Islamic Republic of Pakistan and shall give all notices and pay all fees and other charges in respect of the Works.

2. THE PROCURING ENTITY

2.1 Provision of Site

The Procuring Entity shall provide the Site and right of access thereto at the times stated in the Contract Data.

2.2 Permits etc.

The Procuring Entity shall, if requested by the Contractor, assist him in applying for permits, licenses or approvals which are required for the Works.

2.3 Engineer's/Procuring Entity's Instructions

The Contractor shall comply with all instructions given by the Procuring Entity or the Engineer, if notified by the Procuring Entity, in respect of the Works including the suspension of all or part of the Works.

2.4 Approvals

No approval or consent or absence of comment by the Engineer/Procuring Entity shall affect the Contractor's obligations.

3. ENGINEER'S/PROCURING ENTITY'S REPRESENTATIVES

3.1 Authorized Person

The Procuring Entity shall appoint a duly authorized person to act for him and on his behalf for the purposes of this Contract. Such authorized person shall be duly identified in the Contract Data or otherwise notified in writing to the Contractor as soon as he is so appointed. In either case the Procuring Entity shall notify the Contractor, in writing, the precise scope of the authority of such authorized person at the time of his appointment.

3.2 Engineer's/Procuring Entity's Representative

The name and address of Engineer's/Procuring Entity's Representative is given in Contract Data. However the Contractor shall be notified by the Engineer/Procuring Entity, the delegated duties and authority before the Commencement of Works.

4. THE CONTRACTOR

4.1 General Obligations

The Contractor shall carry out the Works properly and in accordance with the Contract. The Contractor shall provide all supervision, labour, Materials, Plant and Contractor's Equipment which may be required.

4.2 Contractor's Representative

The Contractor shall appoint a representative at site on full time basis to supervise the execution of work and to receive instructions on behalf of the Contractor but only after obtaining the consent of the Procuring Entity for such appointment which consent shall not be unreasonable withheld by the Procuring Entity. Such authorized representative may be substituted/replaced by the Contractor at any time during the Contract Period but only after obtaining the consent of the Procuring Entity as aforesaid.

4.3 Subcontracting

The Contractor shall not subcontract the whole of the Works. The Contractor shall not subcontract any part of the Works without the consent of the Procuring Entity.

4.4 Performance Security

The Contractor shall furnish to the Procuring Entity within fourteen (14) days after receipt of Letter of Acceptance a Performance Security at the option of the bidder, in the form of Bank Draft or Bank Guarantee for the amount and validity specified in Contract Data, in case the contract value is equal to or exceeds Rs.20.00 million. No Performance Security will be needed for contracts values less than Rs.20.00 million. (10 million rule 21)

5. DESIGN BY CONTRACTOR

5.1 Contractor's Design

The Contractor shall carry out design to the extent specified, as referred to in the Contract Data. The Contractor shall promptly submit to the Engineer/Procuring Entity all designs prepared by him. Within fourteen (14) days of receipt the Engineer/Procuring Entity shall notify any comments or, if the design submitted is not in accordance with the Contract, shall reject it stating the reasons. The Contractor shall not construct any element of the Works designed by him within fourteen (14) days after the design has been submitted to the Engineer/Procuring Entity or which has been rejected. Design that has been rejected shall be promptly amended and resubmitted. The Contractor shall resubmit all designs commented on taking these comments into account as necessary.

5.2 Responsibility for Design

The Contractor shall remain responsible for his bided design and the design under this Clause, both of which shall be fit for the intended purposes defined in the Contract and he shall also remain responsible for any infringement of any patent or copyright in respect of the same. The Engineer/Procuring Entity shall be responsible for the Specifications and Drawings.

6. PROCURING ENTITY'S RISKS

6.1 The Procuring Entity's Risks

The Procuring Entity's Risks are:-

- a) war, hostilities (whether war be declared or not), invasion, act of foreign enemies, within the Country;
- b) rebellion, terrorism, revolution, insurrection, military or usurped power, or civil war, within the Country;
- c) riot, commotion or disorder by persons other than the Contractor's personnel and other employees including the personnel and employees of Sub-Contractors, affecting the Site and/or the Works;
- d) Ionizing radiations, or contamination by radio-activity from any nuclear fuel, or from any nuclear waste from the combustion of nuclear fuel, radio-active toxic explosive, or other hazardous properties of any explosive nuclear assembly or nuclear component of such an assembly, except to the extent to which the Contractor/Sub-Contractors may be responsible for the use of any radio-active material;
- e) Pressure waves caused by aircraft or other aerial devices travelling at sonic or supersonic speeds;
- f) use or occupation by the Procuring Entity of any part of the Works, except as may be specified in the Contract;
- g) late handing over of sites, anomalies in drawings, late delivery of designs and drawings of any part of the Works by the Procuring Entity's personnel or by others for whom the Procuring Entity is responsible;
- h) a suspension under Sub-Clause 2.3 unless it is attributable to the Contractor's failure; and
- i) physical obstruction or physical conditions other than climatic conditions, encountered on the Site during the performance of the Works, for which Contractor immediately notified to the Procuring Entity and accepted by the Procuring Entity.

7. TIME FOR COMPLETION

7.1 Execution of the Works

The Contractor shall commence the Works on the Commencement Date and shall proceed expeditiously and without delay and shall complete the Works, subject to Sub-Clause 7.3 below, within the Time for Completion.

7.2 Program

Within the time stated in the Contract Data, the Contractor shall submit to the Engineer/Procuring Entity a program for the Works in the form stated in the Contract Data.

7.3 Extension of Time

The Contractor shall, within such time as may be reasonable under the circumstances, notify the Procuring Entity/Engineer of any event(s) falling within the scope of Sub-Clause 6.1 or 10.3 of these Conditions of Contract and request the Procuring Entity/Engineer for a reasonable extension in the time for the completion of Works. Subject to the aforesaid, the Procuring Entity/Engineer shall determine such reasonable extension in the time for the completion of Works as may be justified in the light of the details/particulars supplied by the Contractor in connection with the such determination by the Procuring Entity/Engineer within such period as may be prescribed by the Procuring Entity/Engineer for the same; and the Procuring Entity shall extend the Time for Completion as determined.

7.4 Late Completion

If the Contractor fails to complete the Works within the Time for Completion, the Contractor's only liability to the Procuring Entity for such failure shall be to pay the amount stated in the Contract Data for each day for which he fails to complete the Works.

8. TAKING-OVER

8.1 Completion

The Contractor may notify the Engineer/Procuring Entity when he considers that the Works are complete.

8.2 Taking-Over Notice

Within fourteen (14) days of the receipt of the said notice of completion from the Contractor the Procuring Entity/Engineer shall either takeover the completed Works and issue a Certificate of Completion to that effect or shall notify the Contractor his reasons for not taking-over the Works. While issuing the Certificate of Completion as aforesaid, the Procuring Entity/Engineer may identify any outstanding items of work which the Contractor shall undertake during the Maintenances Period.

9. REMEDYING DEFECTS

9.1 Remediating Defects

The Contractor shall for a period stated in the Contract Data from the date of issue of the Certificate of Completion carry out, at no cost to the Procuring Entity, repair and rectification work which is necessitated by the earlier execution of poor quality of work or use of below specifications material in the execution of Works and which is so identified by the Procuring Entity/Engineer in writing within the said period. Upon expiry of the said period, and subject to the Contractor's faithfully performing his aforesaid obligations, the Procuring Entity/Engineer shall issue a Maintenance Certificate whereupon all obligations of the Contractor under this Contract shall come to an end.

Failure to remedy any such defects or complete outstanding work within a reasonable time shall entitle the Procuring Entity to carry out all necessary works at the Contractor's cost. However, the cost of remedying defects not attributable to the Contractor shall be valued as a Variation.

9.2 Uncovering and Testing

The Engineer/Procuring Entity may give instruction as to the uncovering and/or testing of any work. Unless as a result of an uncovering and/or testing it is established that the Contractor's design, Materials, Plant or workmanship are not in accordance with the Contract, the Contractor shall be paid for such uncovering and/or testing as a Variation in accordance with Sub-Clause 10.2.

10. VARIATIONS AND CLAIMS

10.1 Right to Vary

The Procuring Entity/Engineer may issue Variation Order(s) in writing. where for any reason it has not been possible for the Procuring Entity/Engineer to issue such Variations Order(s), the Contractor may confirm any verbal orders given by the Procuring Entity/Engineer in writing and if the same are not refuted/denied by the Procuring Entity/Engineer within seven (7) days of the receipt of such confirmation the same shall be deemed to be a Variation Orders for the purposes of this Sub-Clause.

10.2 Valuation of Variations

Variations shall be valued as follows:

- a) at a lump sum price agreed between the Parties, or
- b) where appropriate, at rates in the Contract, or
- c) in the absence of appropriate rates, the rates in the Contract shall be used as the basis for valuation, or failing which

- d) at appropriate new rates, as may be agreed or which the Engineer/Procuring Entity considers appropriate, or
- e) if the Engineer/Procuring Entity so instructs, at day work rates set out in the Contract Data for which the Contractor shall keep records of hours of labour and Contractor's Equipment, and of Materials, used.

10.3 Early Warning

The Contractor shall notify the Engineer/Procuring Entity in writing as soon as he is aware of any circumstance which may delay or disrupt the Works, or which may give rise to a claim for additional payment.

To the extent of the Contractor's failure to notify, which results to the Engineer/Procuring Entity being unable to keep all relevant records or not taking steps to minimize any delay, disruption, or Cost, or the value of any Variation, the Contractor's entitlement to extension of the Time for Completion or additional payment shall be reduced/rejected.

10.4 Valuation of Claims

If the Contractor incurs Cost as a result of any of the Procuring Entity's Risks, the Contractor shall be entitled to the amount of such Cost. If as a result of any Procuring Entity's Risk, it is necessary to change the Works, this shall be dealt with as a Variation subject to Contractor's notification for intention of claim to the Engineer/Procuring Entity within fourteen (14) days of the occurrence of cause.

10.5 Variation and Claim Procedure

The Contractor shall submit to the Engineer/Procuring Entity an itemized make-up of the value of variations and claims within twenty eight (28) days of the instruction or of the event giving rise to the claim. The Engineer/Procuring Entity shall check and if possible agree the value. In the absence of agreement, the Procuring Entity shall determine the value.

11. CONTRACT PRICE AND PAYMENT

11.1 (a) Terms of Payments

The amount due to the Contractor under any Interim Payment Certificate issued by the Engineer pursuant to this Clause, or to any other terms of the Contract, shall, subject to Clause 7.4 of Conditions of Contract (CoC) be paid by the Procuring Entity to the Contractor within 30 days after such Interim Payment Certificate has been jointly verified by Procuring Entity and Contractor, or, in the case of the Final Certificate referred to in Sub Clause 11.5 of CoC, within 60 days after such Final Payment Certificate has been jointly verified by Procuring Entity and Contractor; Provided that the Interim Payment shall be caused in 42 days and Final Payment in 60 days in case of foreign funded project. In the event of the failure of the Procuring Entity to make payment within the times stated, the Procuring Entity shall pay to the

Contractor compensation at the 28 days rate of KIBOR+2% per annum in local currency and LIBOR+1% for foreign currency, upon all sums unpaid from the date by which the same should have been paid. The provisions of this Sub-Clause are without prejudice to the Contractor's entitlement under Clause 12.2 CoC.

(b) **Valuation of the Works**

The Works shall be valued as provided for in the Contract Data, subject to Clause 10.

11.2 Monthly Statements

The Contractor shall be entitled to be paid at monthly intervals:

- a) the value of the Works executed; and
- b) The percentage of the value of Materials and Plant reasonably delivered to the Site, as stated in the Contract Data, subject to any additions or deductions which may be due.

The Contractor shall submit each month to the Engineer/Procuring Entity a statement showing the amounts to which he considers himself entitled.

11.3 Interim Payments

Within a period not exceeding seven (7) days from the date of submission of a statement for interim payment by the Contractor, the Engineer / Procuring Entity shall verify the same and within a period not exceeding thirty (30) days from the said date of submission by the Contractor, the Procuring Entity shall pay to the Contractor the sum verified by the Engineer less retention money at the rate stated in the Contract Data.

11.4 Retention

Retention money shall be paid by the Procuring Entity to the Contractor within fourteen (14) days after either the expiry of the period stated in the Contract Data, or the remedying of notified defects, or the completion of outstanding work, all as referred to in Sub-Clause 9.1, whichever is the later.

11.5 Final Payment

Within sixty (60) days from the date of receipt of the verified final account from the Engineer, the Procuring Entity shall pay to the Contractor any amount due to the Contractor. While making such payment the Procuring Entity may, for reasons to be given to the Contractor in writing, withhold any part or parts of the verified amount.

11.6 Currency

Payment shall be in the currency stated in the Contract Data.



12. DEFAULT

12.1 Default by Contractor

If the Contractor abandons the Works, refuses or fails to comply with a valid instruction of the Engineer/Procuring Entity or fails to proceed expeditiously and without delay, or is, despite a written complaint, in breach of the Contract, the Procuring Entity may give notice referring to this Sub-Clause and stating the default.

If the Contractor has not taken all practicable steps to remedy the default within fourteen (14) days after receipt of the Procuring Entity's notice, the Procuring Entity may by a second notice given within a further twenty one (21) days, terminate the Contract. The Contractor shall then demobilise from the Site leaving behind any Contractor's Equipment which the Procuring Entity instructs, in the second notice, to be used for the completion of the Works at the risk and cost of the Contractor.

12.2 Default by Procuring Entity

If the Procuring Entity fails to pay in accordance with the Contract, or is, despite a written complaint, in breach of the Contract, the Contractor may give notice referring to this Sub-Clause and stating the default. If the default is not remedied within fourteen (14) days after the Procuring Entity's receipt of this notice, the Contractor may suspend the execution of all or parts of the Works.

If the default is not remedied within twenty eight (28) days after the Procuring Entity's receipt of the Contractor's notice, the Contractor may by a second notice given within a further twenty one (21) days, terminate the Contract. The Contractor shall then demobilize from the Site.

12.3 Insolvency

If a Party is declared insolvent under any applicable law, the other Party may by notice terminate the Contract immediately. The Contractor shall then demobilize from the Site leaving behind, in the case of the Contractor's insolvency, any Contractor's Equipment which the Procuring Entity instructs in the notice is to be used for the completion of the Works.

12.4 Payment upon Termination

After termination, the Contractor shall be entitled to payment of the unpaid balance of the value of the Works executed and of the Materials and Plant reasonably delivered to the Site, adjusted by the following:

- a) any sums to which the Contractor is entitled under Sub-Clause 10.4,
- b) any sums to which the Procuring Entity is entitled,
- c) if the Procuring Entity has terminated under Sub-Clause 12.1 or 12.3, the Procuring Entity shall be entitled to a sum equivalent to twenty percent (20%) of the value of parts of the Works not executed at the date of the termination, and

- d) if the Contractor has terminated under Sub-Clause 12.2 or 12.3, the Contractor shall be entitled to the cost of his demobilization together with a sum equivalent to ten percent (10%) of the value of parts of the Works not executed at the date of termination.

The net balance due shall be paid or repaid within twenty eight (28) days of the notice of termination.

13. RISKS AND RESPONSIBILITIES

13.1 Contractor's Care of the Works

Subject to Sub-Clause 9.1, the Contractor shall take full responsibility for the care of the Works from the Commencement Date until the date of the Procuring Entity's/Engineer's issuance of Certificate of Completion under Sub-Clause 8.2. Responsibility shall then pass to the Procuring Entity. If any loss or damage happens to the Works during the above period, the Contractor shall rectify such loss or damage so that the Works conform with the Contract.

Unless the loss or damage happens as a result of any of the Procuring Entity's Risks, the Contractor shall indemnify the Procuring Entity, or his agents against all claims loss, damage and expense arising out of the Works.

13.2 Force Majeure

If Force Majeure occurs, the Contractor shall notify the Engineer/Procuring Entity immediately. If necessary, the Contractor may suspend the execution of the Works and, to the extent agreed with the Procuring Entity demobilize the Contractor's Equipment.

If the event continues for a period of eighty four (84) days, either Party may then give notice of termination which shall take effect twenty eight (28) days after the giving of the notice.

After termination, the Contractor shall be entitled to payment of the unpaid balance of the value of the Works executed and of the Materials and Plant reasonably delivered to the Site, adjusted by the following:

- a) any sums to which the Contractor is entitled under Sub-Clause 10.4,
- b) the cost of his demobilization, and
- c) less any sums to which the Procuring Entity is entitled.

The net balance due shall be paid or repaid within thirty five (35) days of the notice of termination.

14. INSURANCE

14.1 Arrangements

The Contractor shall, prior to commencing the Works, effect insurances of the types,

in the amounts and naming as insured the persons stipulated in the Contract Data except for items (a) to (e) and (i) of the Procuring Entity's Risks under Sub-Clause 6.1. The policies shall be issued by insurers and in terms approved by the Procuring Entity. The Contractor shall provide the Engineer/Procuring Entity with evidence that any required policy is in force and that the premiums have been paid.

14.2 **Default**

If the Contractor fails to effect or keep in force any of the insurances referred to in the previous Sub-Clause, or fails to provide satisfactory evidence, policies or receipts, the Procuring Entity may, without prejudice to any other right or remedy, effect insurance for the cover relevant to such as a default and pay the premiums due and recover the same plus a sum in percentage given in Contractor Data from any other amounts due to the Contractor.

15. **RESOLUTION OF DISPUTES**

15.1 **Engineer's Decision**

If a dispute of any kind whatsoever arises between the Procuring Entity and the Contractor in connection with the Works, the matter in dispute shall, in the first place, be referred in writing to the Engineer, with a copy to the other party. Such reference shall state that it is made pursuant to this Clause. No later than the twenty eight (28) days after the day on which he received such reference, the Engineer shall give notice of his decision to the Procuring Entity and the Contractor. Unless the Contract has already been repudiated or terminated, the Contractor shall, in every case, continue to proceed with the Work with all due diligence, and the Contractor and the Procuring Entity shall give effect forthwith to every such decision of the Engineer unless and until the same shall be revised, as hereinafter provided in an arbitral award.

15.2 **Notice of Dissatisfaction**

If a Party is dissatisfied with the decision of the Engineer or if no decision is given within the time set out in Sub-Clause 15.1 hereabove, the Party may give notice of dissatisfaction referring to this Sub-Clause within fourteen (14) days of receipt of the decision or the expiry of the time for the decision. If no notice of dissatisfaction is given within the specified time, the decision shall be final and binding on the Parties. If notice of dissatisfaction is given within the specified time, the decision shall be binding on the Parties who shall give effect to it without delay unless and until the decision of the Engineer is revised by an arbitrator.

15.3 **Arbitration**

A dispute which has been the subject of a notice of dissatisfaction shall be finally settled as per provisions of Arbitration Act 1940 (Act No. X of 1940) and Rules made thereunder and any statutory modifications thereto. Any hearing shall be held at the place specified in the Contract Data and in the language referred to in Sub-Clause 1.5.

15.4 Resolution of Dispute in Absence of the Engineer

In case no Engineer has been appointed, the dispute, if any, between the Procuring Entity and the Contractor in connection with the Works, shall first be tried to be resolved amicably. In case the dispute could not be resolved amicably, it shall be settled as per provision of Arbitration Act-1940.

16. INTEGRITY PACT

16.1 If the Contractor, or any of his Sub-Contractors, agents or servants is found to have violated or involved in violation of the Integrity Pact signed by the Contractor as Schedule-F to his Bid, then the Procuring Entity shall be entitled to:

- (a) recover from the Contractor an amount equivalent to ten times the sum of any commission, gratification, bribe, finder's fee or kickback given by the Contractor or any of his Sub-Contractors, agents or servants;
- (b) terminate the Contract; and
- (c) recover from the Contractor any loss or damage to the Procuring Entity as a result of such termination or of any other corrupt business practices of the Contractor or any of his Sub-Contractors, agents or servants.

On termination of the Contract under Sub-Para (b) of this Sub-Clause, the Contractor shall demobilize from the Site leaving behind Contractor's Equipment which the Procuring Entity instructs, in the termination notice, to be used for the completion of the Works at the risk and cost of the Contractor. Payment upon such termination shall be made under Sub-Clause 12.4, in accordance with Sub-Para (c) thereof, after having deducted the amounts due to the Procuring Entity under Sub-Para (a) and (c) of this Sub-Clause.



CONTRACT DATA

Sub-Clauses of Conditions of Contract

1.1.3 Procuring Entity’s Drawings, if any: Provided under the relevant section.

The drawings are attached

1.1.4 **The Procuring Entity** means: Pakhtunkhwa Energy Development Organization (PEDO)

1.1.5 **The Contractor** means

1.1.7 **Commencement Date** means the date of issue of Engineer’s Notice to Commence which shall be issued within fourteen (14) days of the signing of the Contract Agreement.

1.1.9 **Time for Completion** is 180 days

1.1.20 **Engineer** is the AGES Consultants, Peshawar

1.3 Documents forming the Contract listed in the order of priority:

- (a) The Contract Agreement
- (b) Letter of Acceptance
- (c) The completed Form of Bid
- (d) Contract Data
- (e) Conditions of Contract
- (f) The completed Schedules to Bid including Schedule of Prices
- (g) The Drawings,
- (h) The Specifications

2.1 **Provision of Site:** Within 15 days of the Commencement Date

3.1 **Authorized person:** Director (M&E)/Focal Person (RHPP)

3.2 Name and address of Engineer’s/Procuring Entity’s representative

Engineer:

Name; AGES Consultants
Address: 57-E, Canal Road, University Town,
Peshawar.

Procuring Entity

Name: Director (M&E)/Focal Person (RHPP)
Address: PEDO House, Sector B/2, Phase V, Hayatabad, Peshawar
Islamic Republic of Pakistan
Tel: 0919217004
Fax: 0919217340

4.4 **Performance Security:**

Amount: Ten (10) percent of the accepted Contract Price

Validity: Till end of the period of Remedying Defects under Clause 9 of Conditions of Contract.

5.1 **Requirements for Contractor's design (if any):** Not Applicable

7.2 **Program:**

Time for submission: Within Seven (07) days of the Commencement Date.

Form of program: Bar Chart or other as approved by the Engineer

7.4 Amount payable due to failure to complete shall be 0.05% per day of the accepted Contract Price up to a maximum of (10%) of sum stated in the Letter of Acceptance.

9.1 **Period for remedying defects:** Twelve (12) months

10.2 (e) **Variation procedure:** Not Applicable

11.1 (a) **Terms of Payments:**

Payment of Contract Price shall be made in the following manners:

- i) Ten percent (10%) of Contract Price shall be paid as interest free mobilization advance payment within twenty one (21) days after the receipt of acceptable Performance Security and Bank Guarantee for such advance payment. The recovery / adjustment of mobilization advance or other advances, if any, is to be affected @ 10% of each IPC starting from the 1st IPC of the executed works. Full recovery of advances, if remains unaccounted for in the IPC's is to be affected in the final payment certificate.
- ii) Seventy five (75%) shall be paid in accordance with Clause 11.2 & 11.3 of Conditions of Contract.
- iii) Ten percent (10%) shall be paid on the date of issuance of Certificate of Completion as per Clause 8.2 of Conditions of Contract, and
- iv) Five percent (5%) shall be paid in accordance with Clause 11.4 of Conditions of Contract.

(b) **Valuation of the Works:**

Re-measurement with estimated/bid quantities in the Schedule of Prices. Measurement shall be made of the net actual quantity of each item of the Permanent works executed at Site as approved by the Engineer and the method of measurements shall be in accordance with the applicable schedule.

11.2 (b) **Percentage of value of Materials and Plant (for day work if Applicable):**

Not Applicable

11.3 **Percentage of retention:** Five (5%)

11.6 **Currency of payment:** Pak. Rupees

14.1 **Insurances:**

Type of cover

The Works

Amount of cover

The sum stated in the Letter of Acceptance plus fifteen percent (15%)

Type of cover

Contractor's Equipment:

Amount of cover

Full replacement cost

Type of cover

Third Party-injury to persons and damage to property

Minimum amount of third party insurance: Pak Rupees 2,000,000 (two million) per occurrence with the number of occurrences un-limited

Workers:

As per law of Islamic Republic of Pakistan

(In each case name of insured is Contractor and Procuring Entity)

14.2 **Amount to be recovered**

Premium plus eight percent (8%)

15.3 **Arbitration**

Place of Arbitration: Peshawar

STANDARD FORMS



FORM OF BID SECURITY

(Bank Guarantee)

Guarantee No. _____

Executed on _____

(Letter by the Guarantor to the Procuring Entity)

Name of Guarantor (Scheduled Bank in Pakistan) with
address: _____Name of Principal (Bidder) with
address: _____Penal Sum of Security (express in words and
figures): _____

Bid Reference No. _____ Date of Bid _____

KNOW ALL MEN BY THESE PRESENTS, that in pursuance of the terms of the Bid and at the request of the said Principal, we the Guarantor above-named are held and firmly bound unto the _____, (hereinafter called The "Procuring Entity") in the sum stated above, for the payment of which sum well and truly to be made, we bind ourselves, our heirs, executors, administrators and successors, jointly and severally, firmly by these presents.

THE CONDITION OF THIS OBLIGATION IS SUCH, that whereas the Principal has submitted the accompanying Bid numbered and dated as above for _____ (Particulars of Bid) to the said Procuring Entity; and

WHEREAS, the Procuring Entity has required as a condition for considering the said Bid that the Principal furnishes a Bid Security in the above said sum to the Procuring Entity, conditioned as under:

- (1) that the Bid Security shall remain valid for a period of twenty eight (28) days beyond the period of validity of the bid;
- (2) that in the event of;
 - (a) the Principal withdraws his Bid during the period of validity of Bid, or
 - (b) the Principal does not accept the correction of his Bid Price, pursuant to Sub-Clause 16.4 (b) of Instructions to Bidders, or
 - (c) failure of the successful bidder to
 - (i) furnish the required Performance Security, in accordance with Sub-Clause IB-21.1 of Instructions to Bidders, or
 - (ii) sign the proposed Contract Agreement, in accordance with Sub-Clauses IB-20.2 & 20.3 of Instructions to Bidders,

the entire sum be paid immediately to the said Procuring Entity for delayed completion and not as penalty for the successful bidder's failure to perform.

NOW THEREFORE, if the successful bidder shall, within the period specified therefore, on the prescribed form presented to him for signature enter into a formal Contract Agreement with the said Procuring Entity in accordance with his Bid as accepted and furnish within fourteen (14) days of receipt of Letter of Acceptance, a Performance Security with good and sufficient surety , as may be required, upon the form prescribed by the said Procuring Entity for the faithful performance and proper fulfilment of the said Contract or in the event of non-withdrawal of the said Bid within the time specified then this obligation shall be void and of no effect, but otherwise to remain in full force and effect.

PROVIDED THAT the Guarantor shall forthwith pay to the Procuring Entity the said sum stated above upon first written demand of the Procuring Entity without cavil or argument and without requiring the Procuring Entity to prove or to show grounds or reasons for such demand, notice of which shall be sent by the Procuring Entity by registered post duly addressed to the Guarantor at its address given above.

PROVIDED ALSO THAT the Procuring Entity shall be the sole and final judge for deciding whether the Principal has duly performed his obligations to sign the Contract Agreement and to furnish the requisite Performance Security within the time stated above, or has defaulted in fulfilling said requirements and the Guarantor shall pay without objection the sum stated above upon first written demand from the Procuring Entity forthwith and without any reference to the Principal or any other person.

IN WITNESS WHEREOF, the above bounded Guarantor has executed the instrument under its seal on the date indicated above, the name and seal of the Guarantor being hereto affixed and these presents duly signed by its undersigned representative pursuant to authority of its governing body.

Guarantor (Bank)

Witness:
1. _____

Corporate Secretary (Seal)

1. Signature _____
2. Name _____
3. Title _____

2. _____

(Name, Title & Address)

Corporate Guarantor (Seal)

**FORM OF PERFORMANCE SECURITY
(Bank Guarantee)**

Guarantee No. _____
Executed on _____

(Letter by the Guarantor to the Procuring Entity)

Name of Guarantor (Scheduled Bank in Pakistan) with
address: _____

Name of Principal (Contractor) with
address: _____

Penal Sum of Security (express in words and
figures) _____

Letter of Acceptance No. _____ Dated _____

KNOW ALL MEN BY THESE PRESENTS, that in pursuance of the terms of the Bidding Documents and above said Letter of Acceptance (hereinafter called the Documents) and at the request of the said Principal we, the Guarantor above named, are held and firmly bound unto the _____ (hereinafter called the Procuring Entity) in the penal sum of the amount stated above, for the payment of which sum well and truly to be made to the said Procuring Entity, we bind ourselves, our heirs, executors, administrators and successors, jointly and severally, firmly by these presents.

THE CONDITION OF THIS OBLIGATION IS SUCH, that whereas the Principal has accepted the Procuring Entity's above said Letter of Acceptance for _____ (Name of Contract) for the _____ (Name of Project).

NOW THEREFORE, if the Principal (Contractor) shall well and truly perform and fulfill all the undertakings, covenants, terms and conditions of the said Documents during the original terms of the said Documents and any extensions thereof that may be granted by the Procuring Entity, with or without notice to the Guarantor, which notice is, hereby, waived and shall also well and truly perform and fulfill all the undertakings, covenants terms and conditions of the Contract and of any and all modifications of the said Documents that may hereafter be made, notice of which modifications to the Guarantor being hereby waived, then, this obligation to be void; otherwise to remain in full force and virtue till all requirements of Clause 9, Remedying Defects, of Conditions of Contract are fulfilled.

Our total liability under this Guarantee is limited to the sum stated above and it is a condition of any liability attaching to us under this Guarantee that the claim for payment in writing shall be received by us within the validity period of this Guarantee, failing which we shall be discharged of our liability, if any, under this Guarantee.

We, _____ (the Guarantor), waiving all objections and defences under the Contract, do hereby irrevocably and independently guarantee to pay to the Procuring Entity without delay upon the Procuring Entity's first written demand without cavil or arguments and without requiring the Procuring Entity to prove or to show grounds or reasons for such demand any sum or sums up to the amount stated above, against the Procuring Entity's written declaration that the Principal has refused or failed to perform the obligations under the Contract, for which payment will be effected by the Guarantor to Procuring Entity's designated Bank & Account Number.

PROVIDED ALSO THAT the Procuring Entity shall be the sole and final judge for deciding whether the Principal (Contractor) has duly performed his obligations under the Contract or has defaulted in fulfilling said obligations and the Guarantor shall pay without objection any sum or sums up to the amount stated above upon first written demand from the Procuring Entity forthwith and without any reference to the Principal or any other person.

IN WITNESS WHEREOF, the above bounded Guarantor has executed this Instrument under its seal on the date indicated above, the name and corporate seal of the Guarantor being hereto affixed and these presents duly signed by its undersigned representative, pursuant to authority of its governing body.

	_____ Guarantor (Bank)
Witness:	
1. _____	1. Signature _____
_____	2. Name _____
Corporate Secretary (Seal)	3. Title _____
2. _____	

(Name, Title & Address)	_____ Corporate Guarantor (Seal)

FORM OF CONTRACT AGREEMENT

THIS CONTRACT AGREEMENT (hereinafter called the "Agreement") made on the _____ day of _____ 200 _____ between _____ (hereinafter called the "Procuring Entity") of the one part and _____ (hereinafter called the "Contractor") of the other part.

WHEREAS the Procuring Entity is desirous that certain Works, viz _____ should be executed by the Contractor and has accepted a Bid by the Contractor for the execution and completion of such Works and the remedying of any defects therein.

NOW this Agreement witnesseth as follows:

1. In this Agreement words and expressions shall have the same meanings as are respectively assigned to them in the Conditions of Contract hereinafter referred to.
2. The following documents after incorporating addenda, if any except those parts relating to Instructions to Bidders, shall be deemed to form and be read and construed as part of this Agreement, viz:
 - (a) The Letter of Acceptance;
 - (b) The completed Form of Bid along with Schedules to Bid;
 - (c) Conditions of Contract & Contract Data;
 - (d) The priced Schedule of Prices;
 - (e) The Specifications; and
 - (f) The Drawings
3. In consideration of the payments to be made by the Procuring Entity to the Contractor as hereinafter mentioned, the Contractor hereby covenants with the Procuring Entity to execute and complete the Works and remedy defects therein in conformity and in all respects within the provisions of the Contract.
4. The Procuring Entity hereby covenants to pay the Contractor, in consideration of the execution and completion of the Works as per provisions of the Contract, the Contract Price or such other sum as may become payable under the provisions of the Contract at the times and in the manner prescribed by the Contract.

IN WITNESS WHEREOF the parties hereto have caused this Contract Agreement to be executed on the day, month and year first before written in accordance with their respective laws.

Signature of the Contactor

Signature of the Procuring Entity

(Seal)

(Seal)

Signed, Sealed and Delivered in the presence of:

Witness:

Witness:

(Name, Title and Address)

(Name, Title and Address)



FORM OF BANK GUARANTEE FOR ADVANCE PAYMENT

Guarantee No. _____

Executed on _____

(Letter by the Guarantor to the Procuring Entity)

WHEREAS the _____ (hereinafter called the Procuring Entity) has entered into a Contract for _____

_____ (Particulars of Contract), with

_____ (hereinafter called the Contractor).

AND WHEREAS the Procuring Entity has agreed to advance to the Contractor, at the Contractor's request, an amount of Rs. _____ (Rupees _____) which amount shall be advanced to the Contractor as per provisions of the Contract.

AND WHEREAS the Procuring Entity has asked the Contractor to furnish Guarantee to secure the advance payment for the performance of his obligations under the said Contract.

AND WHEREAS _____ (Scheduled Bank) (hereinafter called the Guarantor) at the request of the Contractor and in consideration of the Procuring Entity agreeing to make the above advance to the Contractor, has agreed to furnish the said Guarantee.

NOW THEREFORE the Guarantor hereby guarantees that the Contractor shall use the advance for the purpose of above mentioned Contract and if he fails, and commits default in fulfillment of any of his obligations for which the advance payment is made, the Guarantor shall be liable to the Procuring Entity for payment not exceeding the aforementioned amount.

Notice in writing of any default, of which the Procuring Entity shall be the sole and final judge, as aforesaid, on the part of the Contractor, shall be given by the Procuring Entity to the Guarantor, and on such first written demand payment shall be made by the Guarantor of all sums then due under this Guarantee without any reference to the Contractor and without any objection.

This Guarantee shall come into force as soon as the advance payment has been credited to the account of the Contractor.

This Guarantee shall expire not later than _____

by which date we must have received any claims by registered letter, telegram, telex or e-mail.

It is understood that you will return this Guarantee to us on expiry or after settlement of the total amount to be claimed hereunder.

Witness:

1. _____

Corporate Secretary (Seal)

2. _____

(Name, Title & Address)

Guarantor (Scheduled Bank)

1. Signature _____

2. Name _____

3. Title _____

Corporate Guarantor (Seal)



SPECIFICATIONS



SPECIFICATIONS

A. SPECIAL PROVISIONS

1. General

The Executing Agency for implementation of the Project is the PEDO, Government of KP, headed by the Chief Executive Officer. The authorized representative for implementation of the Works under the Contract is the Director (E&M)/Focal Person (RHPP) on behalf of the PEDO, whereas AGES Consultants shall perform the role of the “Engineer”.

Ranolia Hydropower Project (RHPP), located in the Ranolia Valley of Lower Kohistan District, Khyber Pakhtunkhwa Province, has already been constructed by another contractor. Dubair Bazar is about 20 Km north of Besham along main Karakoram Highway (KKH).

The actual Site for the Works (to be executed under this contract) is located near Dubair Bazar on the right bank of Dubair Khwar upstream of its confluence with Indus River, about 800 m from the KKH, where a powerhouse and an open switchyard have already been constructed as components of the RHPP.



The access road condition to the Site is not good and must be appraised by the Bidders prior to bidding as the Contractor shall be entirely responsible for ensuring accessibility to the Site.

2. Scope of Work

The Scope of Work comprises execution and completion of the Works and the remedying of any defects therein and, except in so far as the contract otherwise provides, the provision of all labor, materials, equipment, plant, temporary works and everything whether of a temporary or permanent nature required in and for such execution, completion and remedying so far as the necessity for providing the same is specified in or can reasonably be inferred from the contract.

The Scope of Work to be carried out under this contract comprise construction of about 225m Protection Embankment along Dubair Khwar upstream and in front of the Powerhouse, complete in all respects as per drawings and specifications. The Works shall also involve excavation, riprap, mass concrete, compacted fill and boulders fill, etc. as specified.

3. Drawings

Tender Drawings are given next in this document. However, after award of the contract, the Tender Drawings will be replaced by the Construction Drawings, with necessary modifications, if required. The Works shall be executed in conformity with the Construction Drawings and Specifications as per contract.

4. Quality of Materials

All materials furnished under the contract shall be new and unused and in compliance with the requirements of the contract.

All material and equipment furnished and all work performed under this contract will be subject to inspection by the Engineer at all times and in all states of completion both off-Site and on-Site. The contractor shall furnish promptly without additional charge, all facilities, labour and materials reasonably needed for performing such inspection and testing as may be required by the Engineer.

The cost of materials sampling, transportation and testing, etc. and any risks associated therewith shall be deemed to be included in the rates and prices of the various items in the Schedule of Prices / BOQ and no separate payment in their respect shall be made.

5. Site Facilities

The contractor shall be responsible for arrangement and maintenance of all facilities including but not limited to accommodation, storage, medical and praying facility, fire protection, security and transportation of the manpower, equipment, plant and materials to the Site.

The cost of all such facilities and any risks associated therewith shall be deemed to be included in the rates and prices of the various items in the Schedule of Prices / BOQ and no separate payment in their respect shall be made.

6. Damage to Property and Utilities owned by Others

The contractor shall conduct his operations, make necessary arrangements, take suitable precautions and perform all required work incidental to the protection of and avoidance of interference with the property and utilities owned by others, within the areas of his operations in connection with the contract and the cost thereof and of any risks therewith shall be borne by the contractor and the contractor shall save harmless and indemnify the Procuring Entity/Engineer in respect of all claims, demands, proceedings, damages, costs, charges and expenses whatsoever arising out of or in relation to any such interference.

B. TECHNICAL SPECIFICATIONS

The technical specifications, prescribed in the relevant Parts of the “Technical Specifications of Market Rate Analysis (MRS) Year 2022, prepared by the GoKP”, for development projects and repair / maintenance Works, are to be applied for execution and completion of the Works under the Contract.

Copy of relevant portions of MRS 2022 will be provided to the Bidder, whose bid has been determined to be substantially responsive to the Bidding Documents and who has offered the lowest evaluated bid price for award of Contract

DRAWINGS



List of Maps / Drawings

- Project Location Map
- Project Layout Plan
- Tender Drawings - Attached as separate Volume



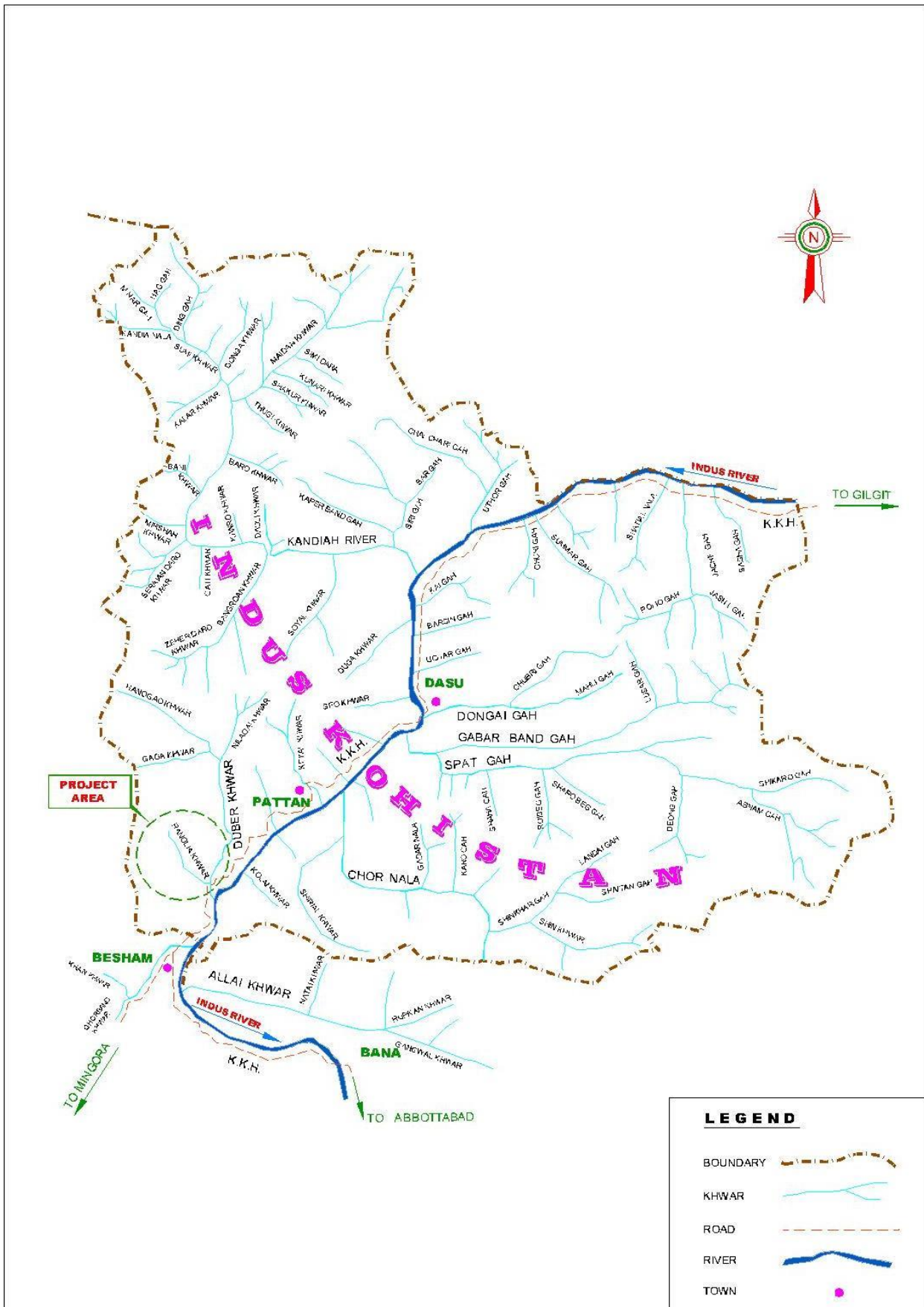

PROJECT LOCATION

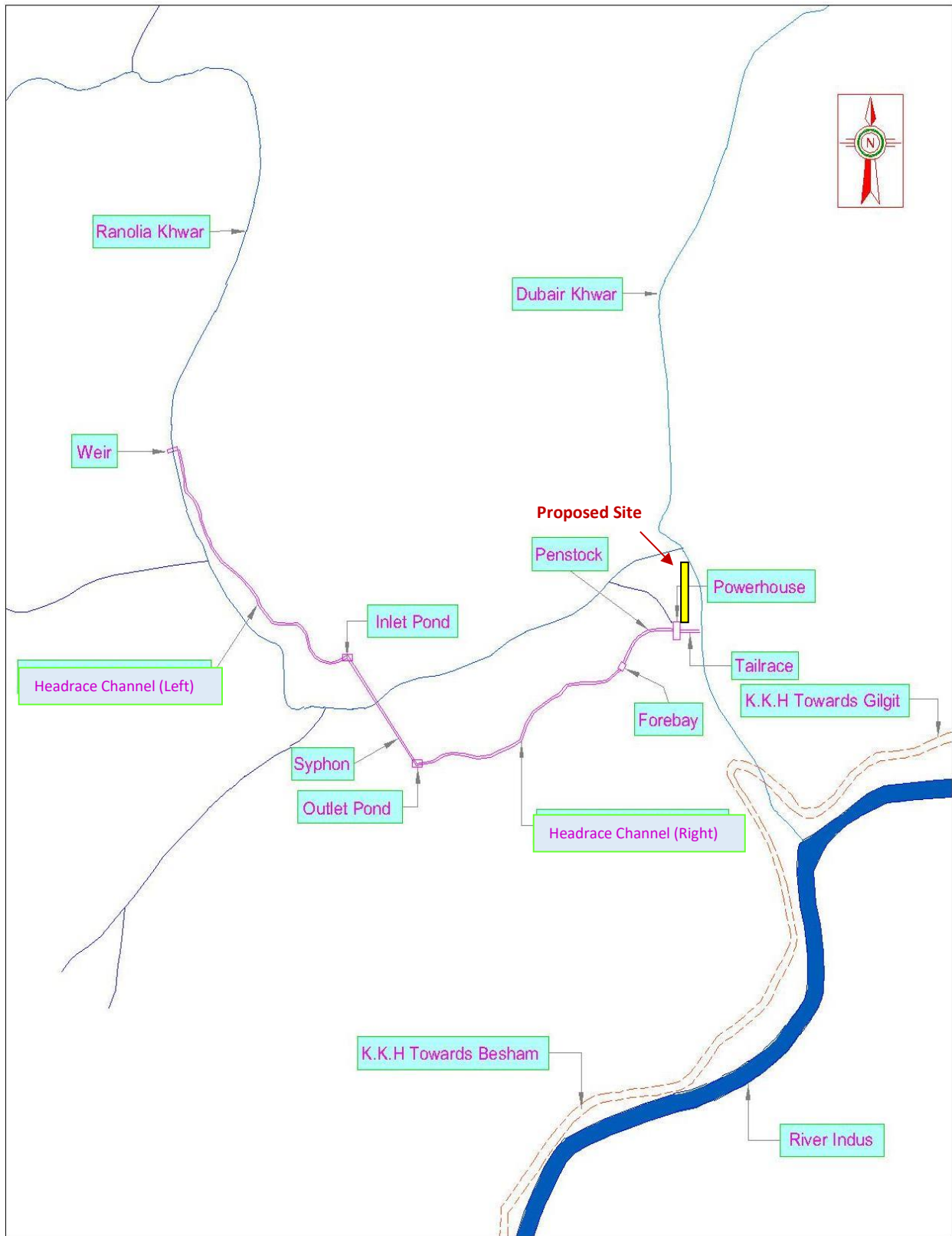

PROJECT LAYOUT PLAN

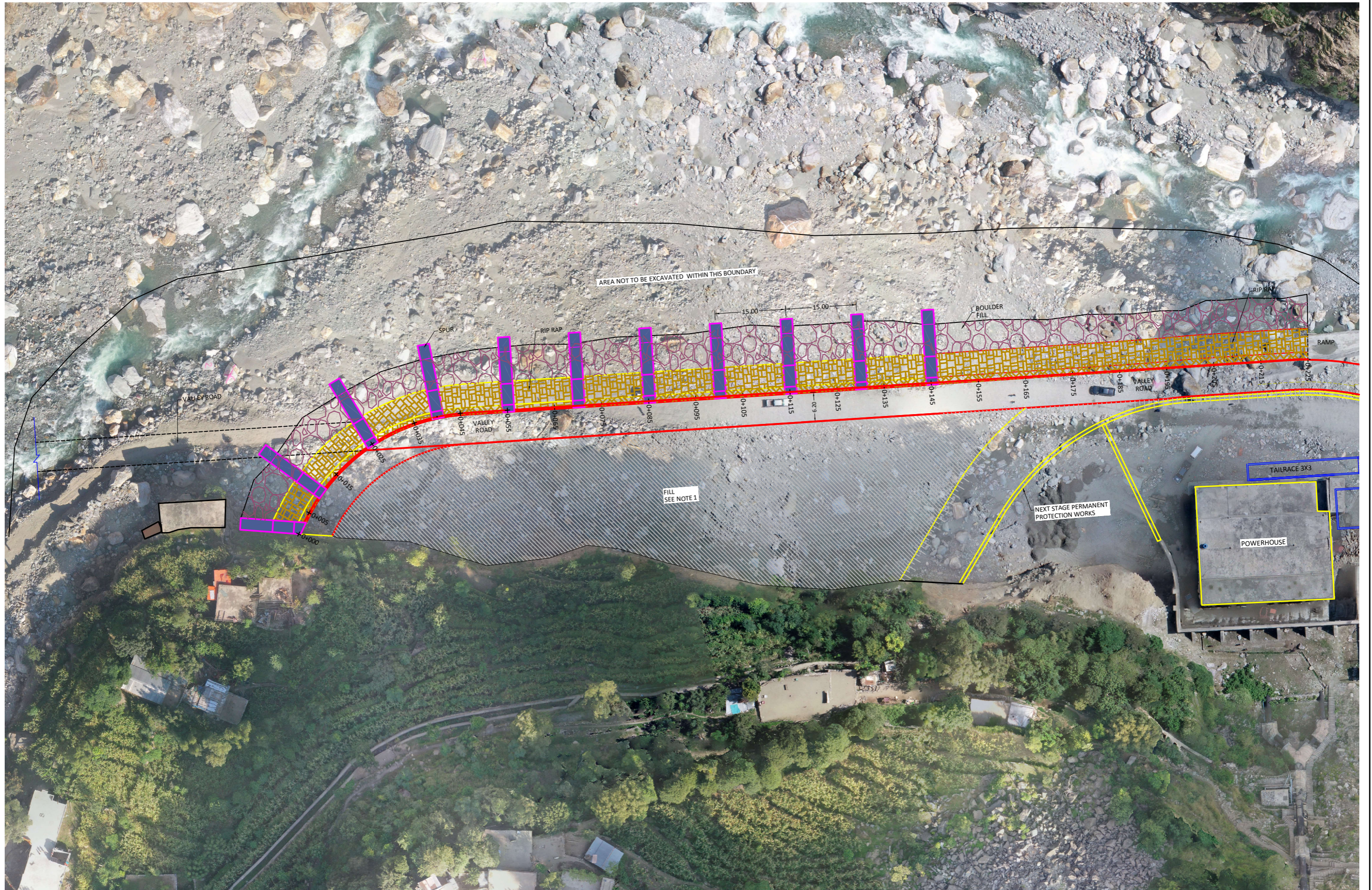



CLIENT	CONSULTANTS	PROJECT NAME	REFERENCES				SHEET CONTENTS
 PAKHTUNKHWA ENERGY DEVELOPMENT ORGANIZATION GOVERNMENT OF KHYBER PAKHTUNKHWA	 AGES CONSULTANTS	REHABILITATION AND RESTORATION OF RANOLIA HYDROPOWER PROJECT	DRAWN BY	AHMAD MAZHAR	DRAWING NO	PE-PLN-01	CONSTRUCTION OF PROTECTION EMBANKMENT U/S OF POWERHOUSE RD 0+000 TO 0+225
DESIGNED BY	ZAHOOR AHMAD	REVISION					
CHECKED BY	M. ISHAQ	DATE	APRIL, 2023				
APPROVED BY	KHALIL HUSSAIN	SCALE	1:750				

- NOTES:
- 1: MATERIAL FROM EXCAVATION IN SHINGLE OR GRAVEL FORMATION NOT REQUIRING BLAST.
 - 2: MATERIAL FROM EXCAVATION IN SHINGLE OR GRAVEL FORMATION NOT REQUIRING BLAST AND COMPACTION BY MECHANICAL MEANS UPTO 90% MMDD.
 - 3: EMBANKMENT FORMATION IN ORDINARY SOIL AND COMPACTION BY MECHANICAL MEANS AT OMC TO 90 MMDD.

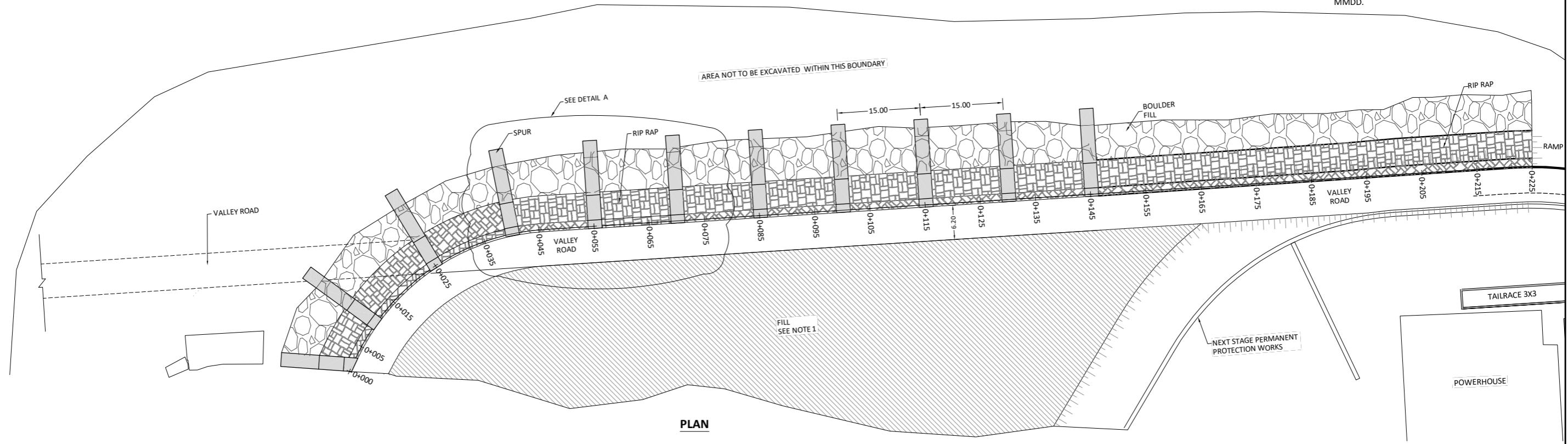

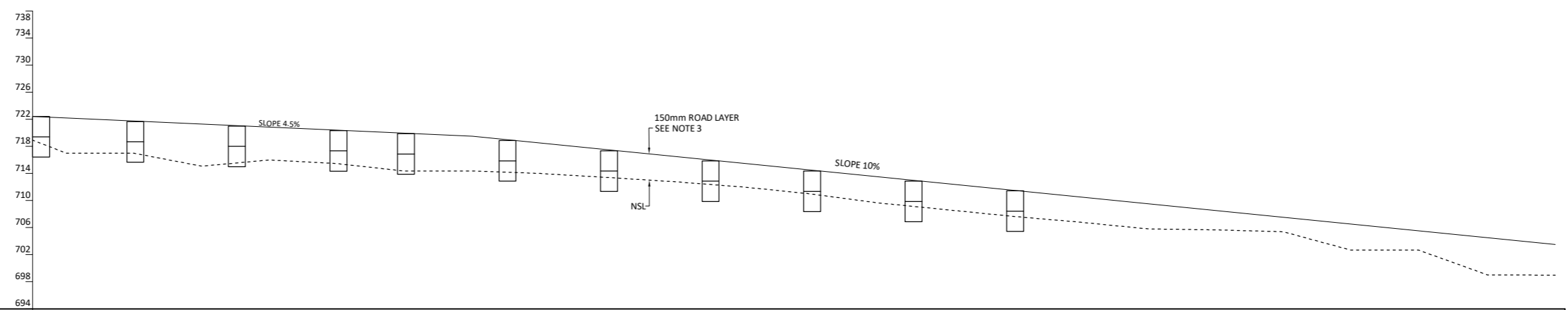

PLAN



SHINGLE ROAD	722.409	722.185	721.738	721.290	720.842	720.395	719.947	719.500	718.500	717.500	716.500	715.500	714.500	713.500	712.500	711.500	710.500	709.500	708.500	707.500	706.500	705.500	704.500	703.500
ORIGINAL GROUND LEVELS	718.918	717.000	716.991	715.072	716.000	715.455	714.347	714.371	714.000	713.403	712.769	712.000	710.975	709.648	708.648	707.650	706.780	705.805	705.661	705.337	702.667	702.626	702.004	698.968
CHAINAGE	0.00	05.00	15.00	25.00	35.00	45.00	55.00	65.00	75.00	85.00	95.00	105.00	115.00	125.00	135.00	145.00	155.00	165.00	175.00	185.00	195.00	205.00	215.00	225.00

LONGITUDINAL PROFILE

 <p>PAKHTUNKHWA ENERGY DEVELOPMENT ORGANIZATION GOVERNMENT OF KHYBER PAKHTUNKHWA</p>	 <p>AGES CONSULTANTS</p>	<p>PROJECT NAME</p> <p>REHABILITATION AND RESTORATION OF RANOLIA HYDROPOWER PROJECT</p>	REFERENCES				<p>SHEET CONTENTS</p> <p>CONSTRUCTION OF PROTECTION EMBANKMENT U/S OF POWERHOUSE PLAN AND PROFILE RD 0+000 TO 0+225</p>
			DRAWN BY	AHMAD MAZHAR	DRAWING NO	PE-PLN-02	
			DESIGNED BY	ZAHOR AHMAD	REVISION		
			CHECKED BY	M. ISHAQ	DATE	APRIL, 2023	
APPROVED BY	KHALIL HUSSAIN	SCALE	1:750				

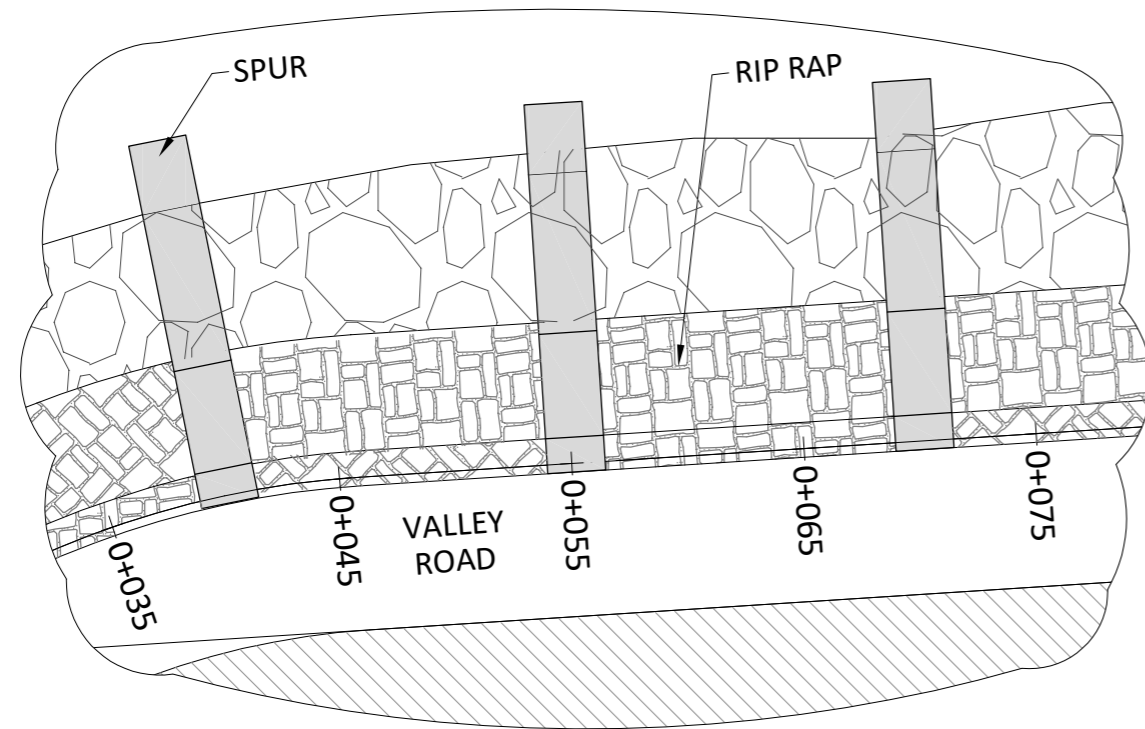

DETAIL A - EMBANKMENT ENLARGED PLAN

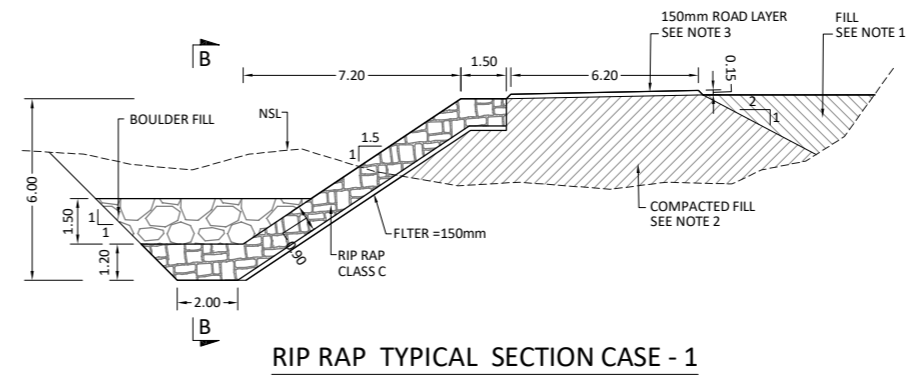

RIP RAP TYPICAL SECTION CASE - 1

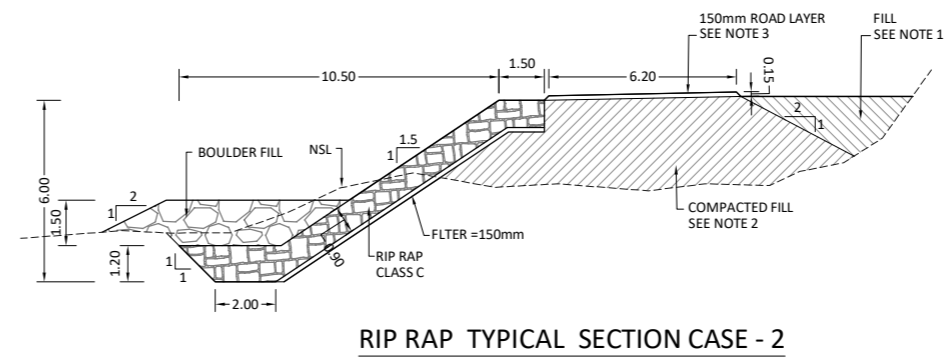

RIP RAP TYPICAL SECTION CASE - 2

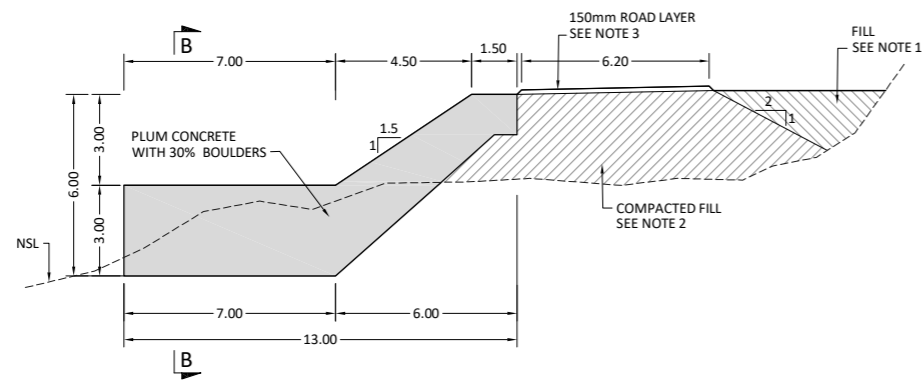

SPUR TYPICAL SECTION CASE - 1

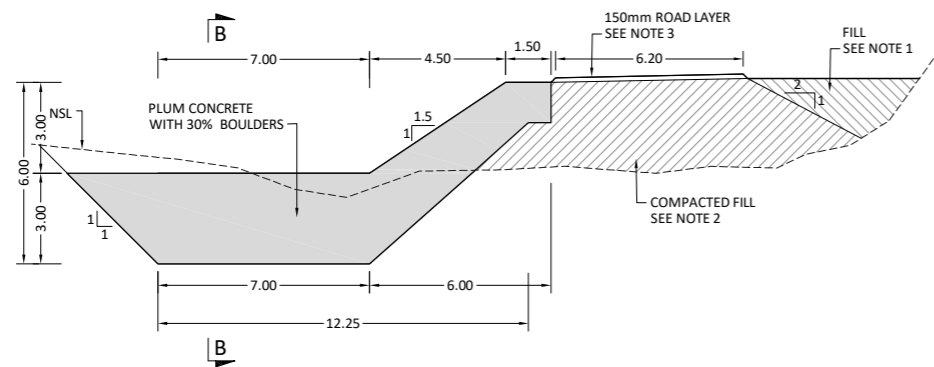

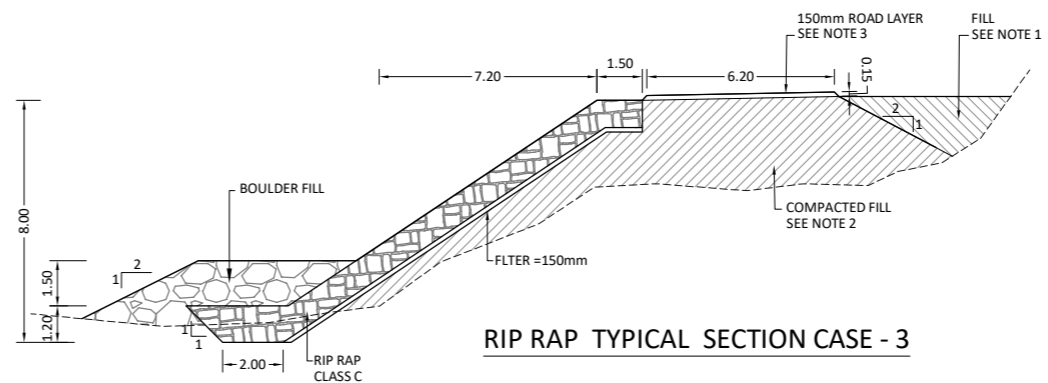

SPUR TYPICAL SECTION CASE - 2



RIP RAP TYPICAL SECTION CASE - 3

- NOTES:
- 1: MATERIAL FROM EXCAVATION IN SHINGLE OR GRAVEL FORMAT NOT REQUIRING BLAST.
 - 2: MATERIAL FROM EXCAVATION IN SHINGLE OR GRAVEL FORMAT NOT REQUIRING BLAST AND COMPACTION BY MECHANICAL MEANS UPTO 90% MMDD.
 - 3: EMBANKMENT FORMATION IN ORDINARY SOIL AND COMPACTION BY MECHANICAL MEANS AT OMC TO 90% MMDD.

CLIENT	CONSULTANTS	PROJECT NAME	REFERENCES				SHEET CONTENTS
			DRAWN BY	AHMAD MAZHAR	DRAWING NO	PE-TYP-01	
 PAKHTUNKHWA ENERGY DEVELOPMENT ORGANIZATION GOVERNMENT OF KHYBER PAKHTUNKHWA	 AGES CONSULTANTS	REHABILITATION AND RESTORATION OF RANOLIA HYDROPOWER PROJECT	DESIGNED BY	ZAHOOR AHMAD	REVISION		
			CHECKED BY	M. ISHAQ	DATE	APRIL, 2023	
			APPROVED BY	KHALIL HUSSAIN	SCALE	1:250	
			CONSTRUCTION OF PROTECTION EMBANKMENT U/S OF POWERHOUSE TYPICAL SECTIONS				

NOTES:

- 1: MATERIAL FROM EXCAVATION IN SHINGLE OR GRAVEL FORMATION NOT REQUIRING BLAST.
- 2: MATERIAL FROM EXCAVATION IN SHINGLE OR GRAVEL FORMATION NOT REQUIRING BLAST AND COMPACTION BY MECHANICAL MEANS UPTO 90% MMDD.
- 3: EMBANKMENT FORMATION IN ORDINARY SOIL AND COMPACTION BY MECHANICAL MEANS AT OMC TO 90% MMDD.

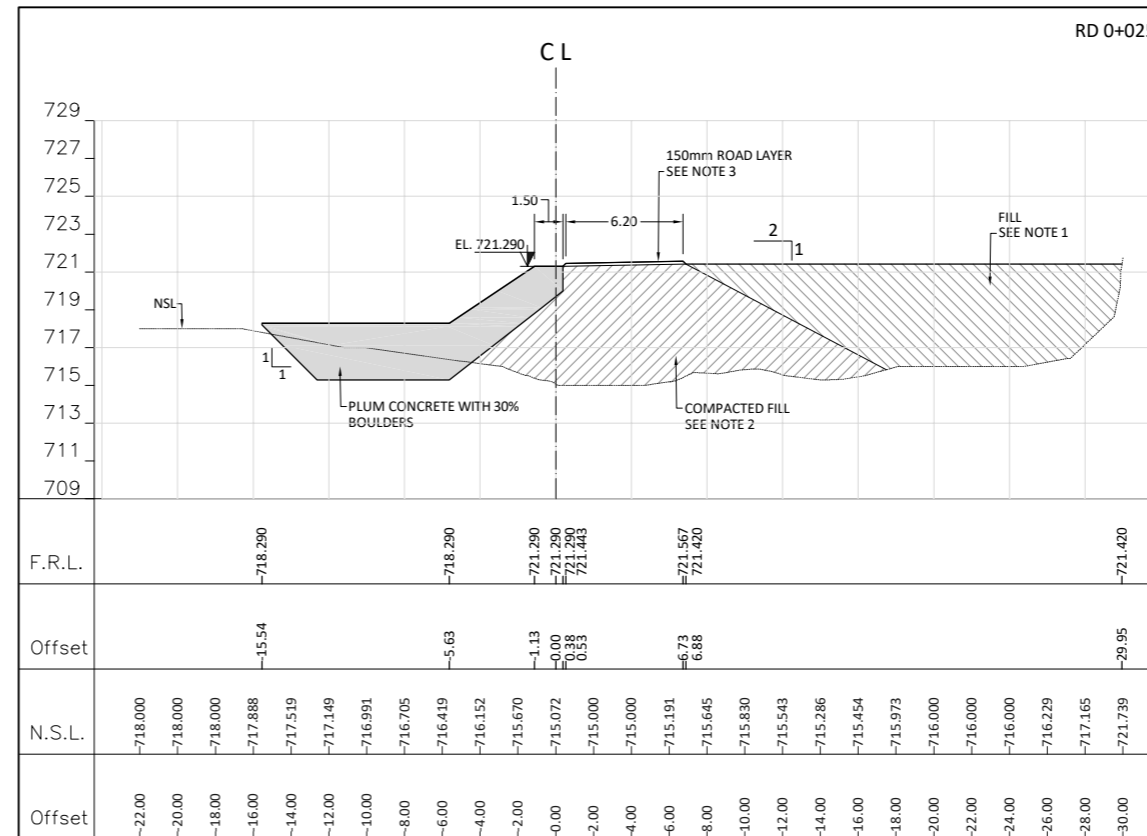
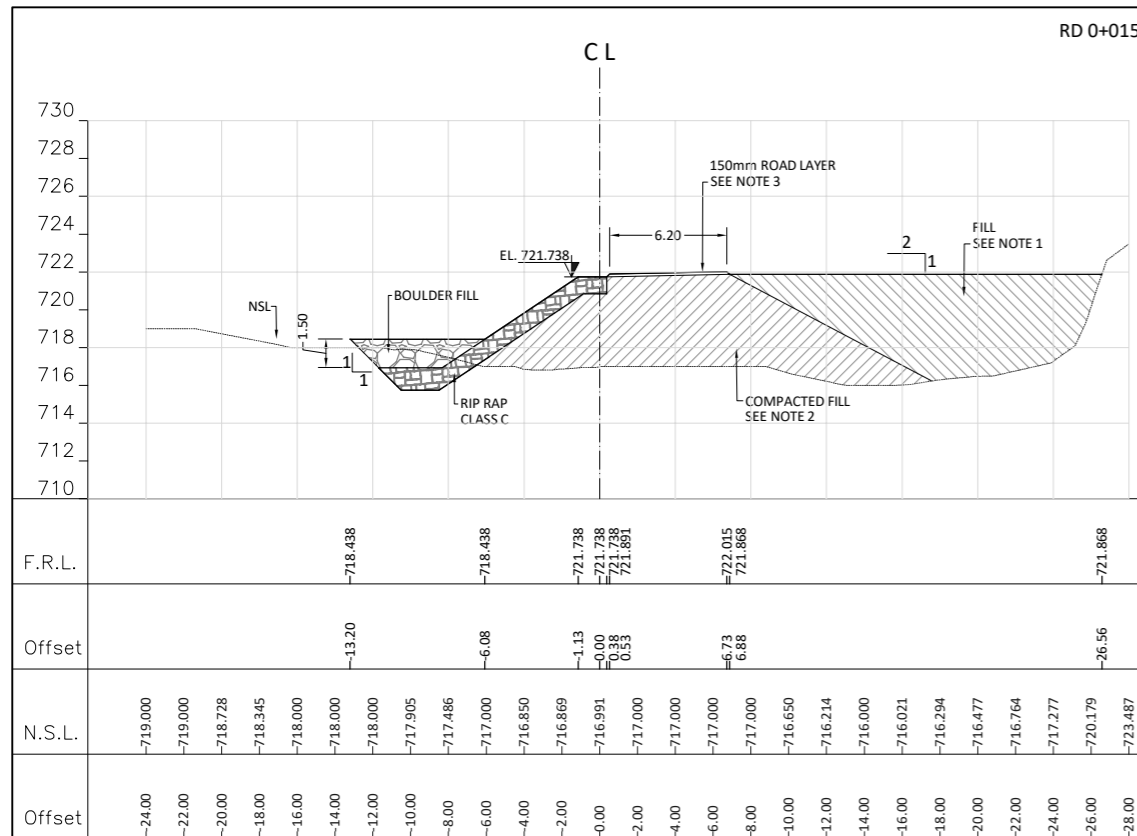
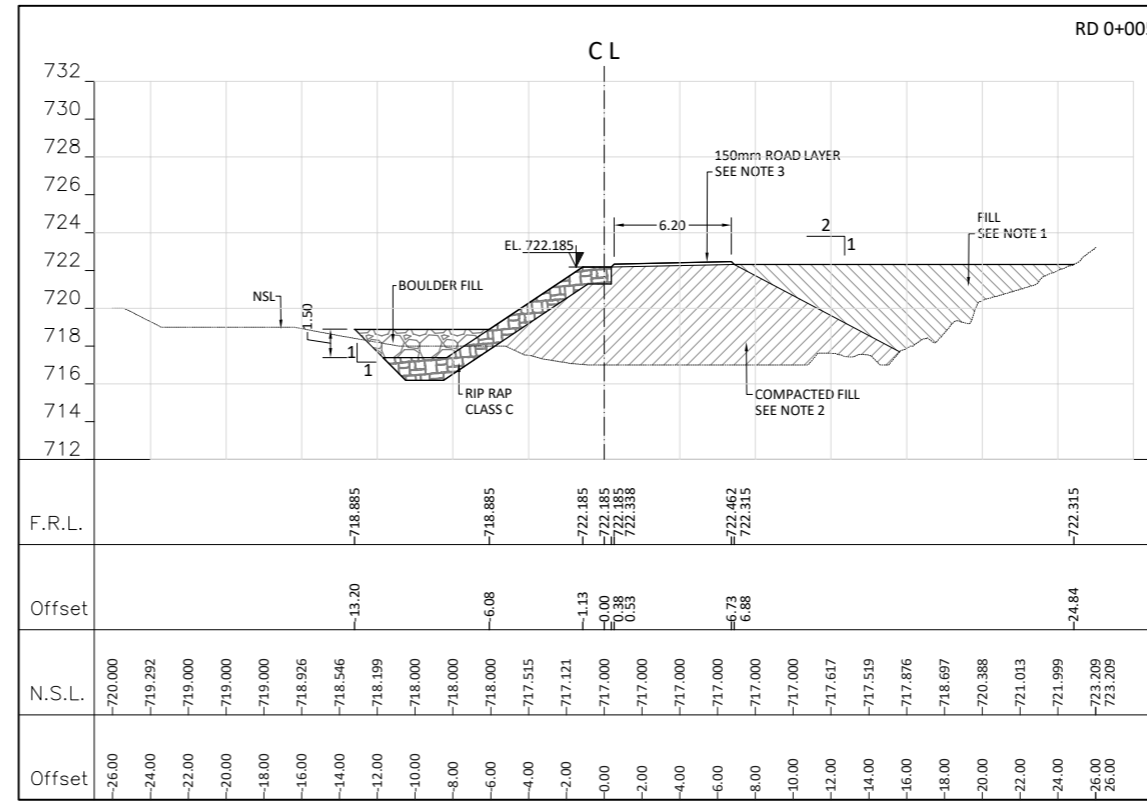
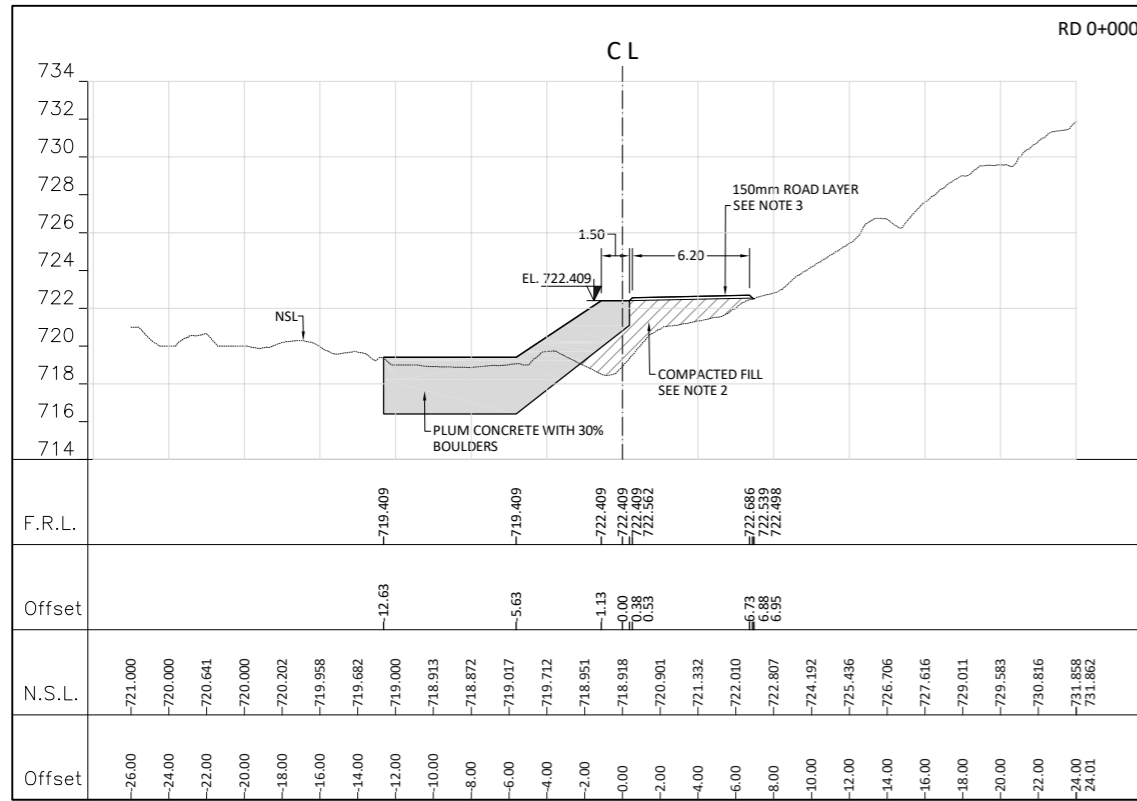

CLIENT	CONSULTANTS	PROJECT NAME	REFERENCES				SHEET CONTENTS
			DRAWN BY	AHMAD MAZHAR	DRAWING NO	PE-SEC-01	
<p>PAKHTUNKHWA ENERGY DEVELOPMENT ORGANIZATION GOVERNMENT OF KHYBER PAKHTUNKHWA</p>	<p>AGES CONSULTANTS</p>	<p>REHABILITATION AND RESTORATION OF RANOLIA HYDROPOWER PROJECT</p>	DESIGNED BY	ZAHOOH AHMAD	REVISION		
			CHECKED BY	M. ISHAQ	DATE	APRIL, 2023	
			APPROVED BY	KHALIL HUSSAIN	SCALE	1:400	
			<p>CONSTRUCTION OF PROTECTION EMBANKMENT U/S OF POWERHOUSE CROSS SECTIONS (SHEET 01 OF 06)</p>				

- NOTES:
- 1: MATERIAL FROM EXCAVATION IN SHINGLE OR GRAVEL FORMATION NOT REQUIRING BLAST.
 - 2: MATERIAL FROM EXCAVATION IN SHINGLE OR GRAVEL FORMATION NOT REQUIRING BLAST AND COMPACTION BY MECHANICAL MEANS UPTO 90% MMDD.
 - 3: EMBANKMENT FORMATION IN ORDINARY SOIL AND COMPACTION BY MECHANICAL MEANS AT OMCC TO 90% MMDD.

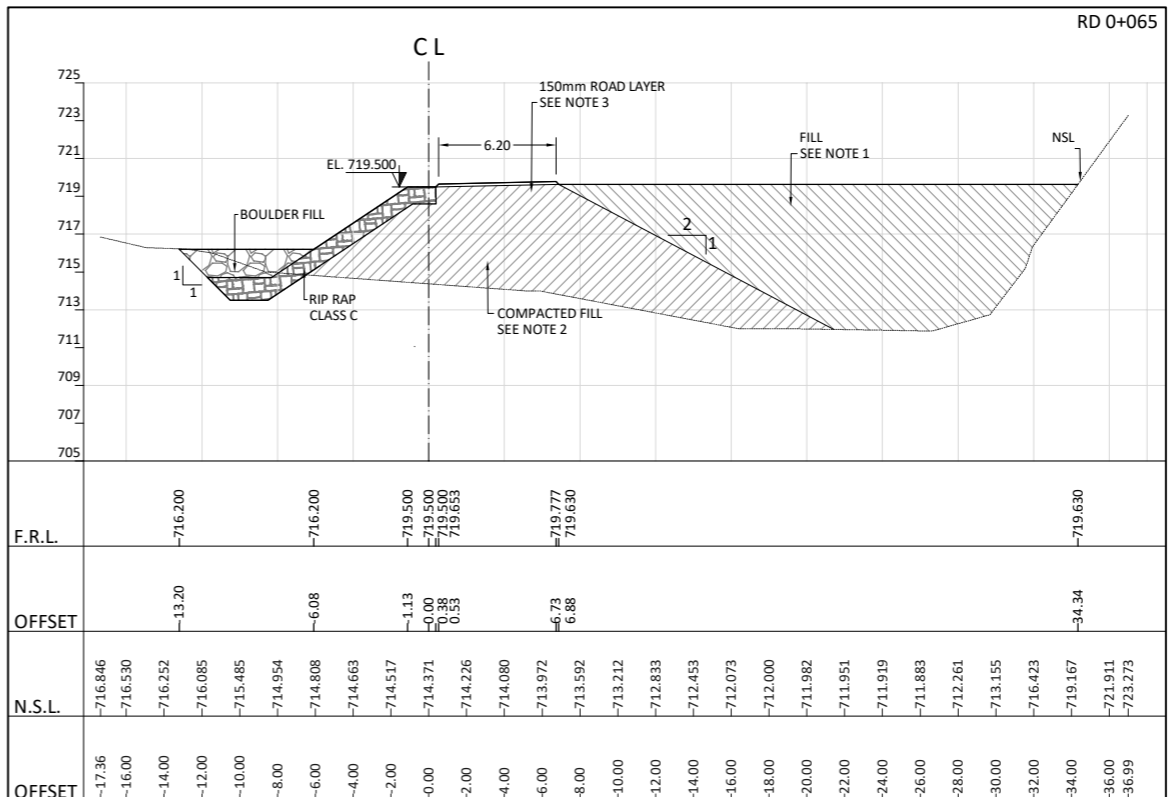
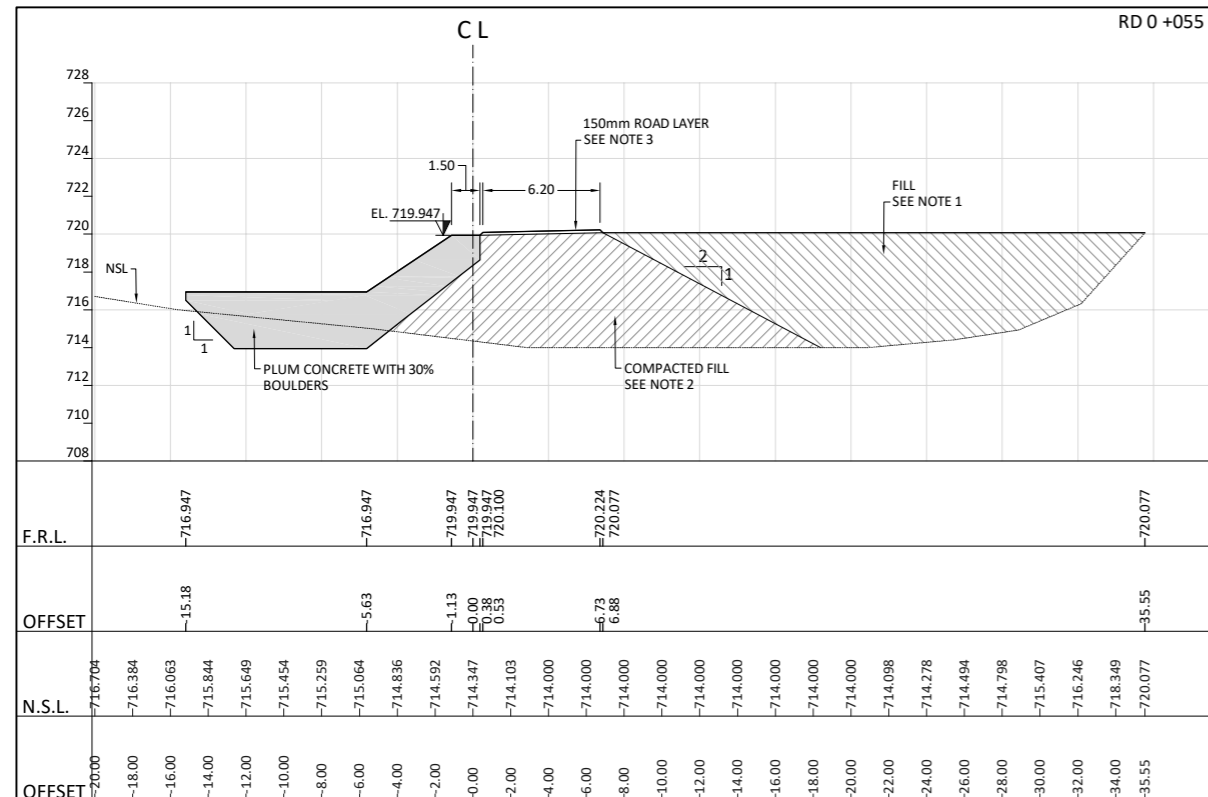
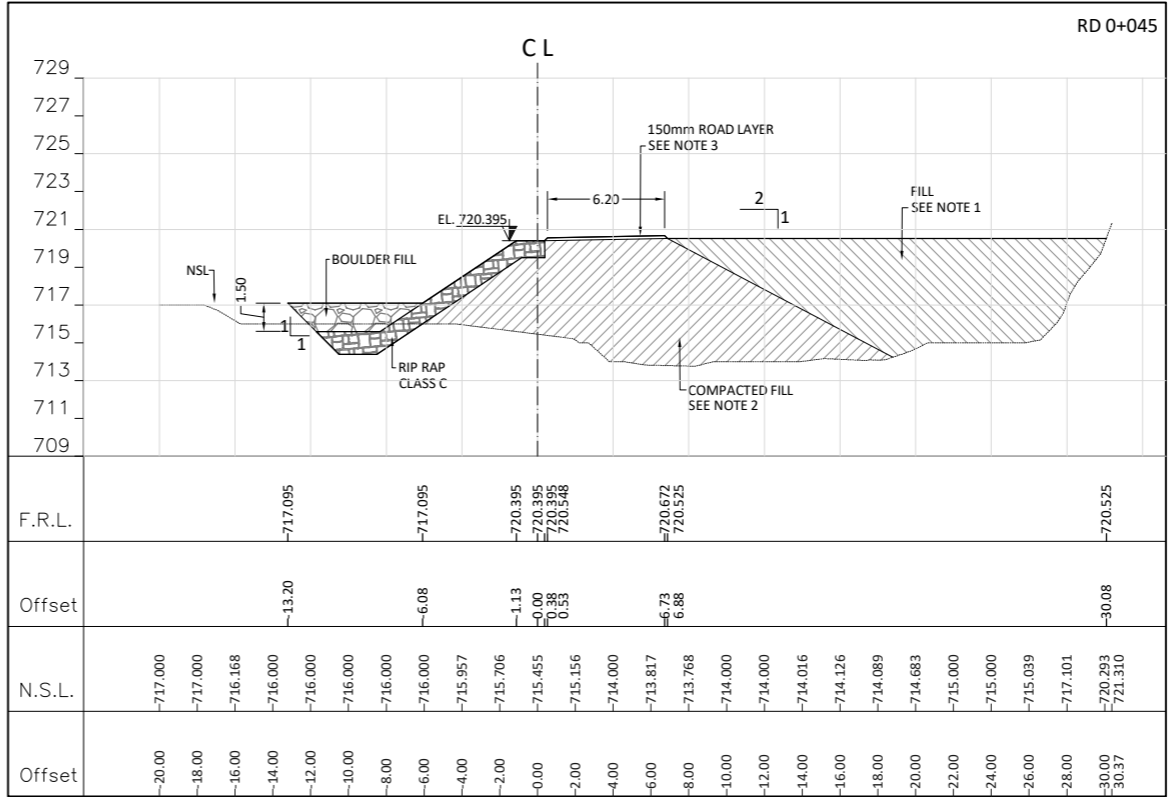
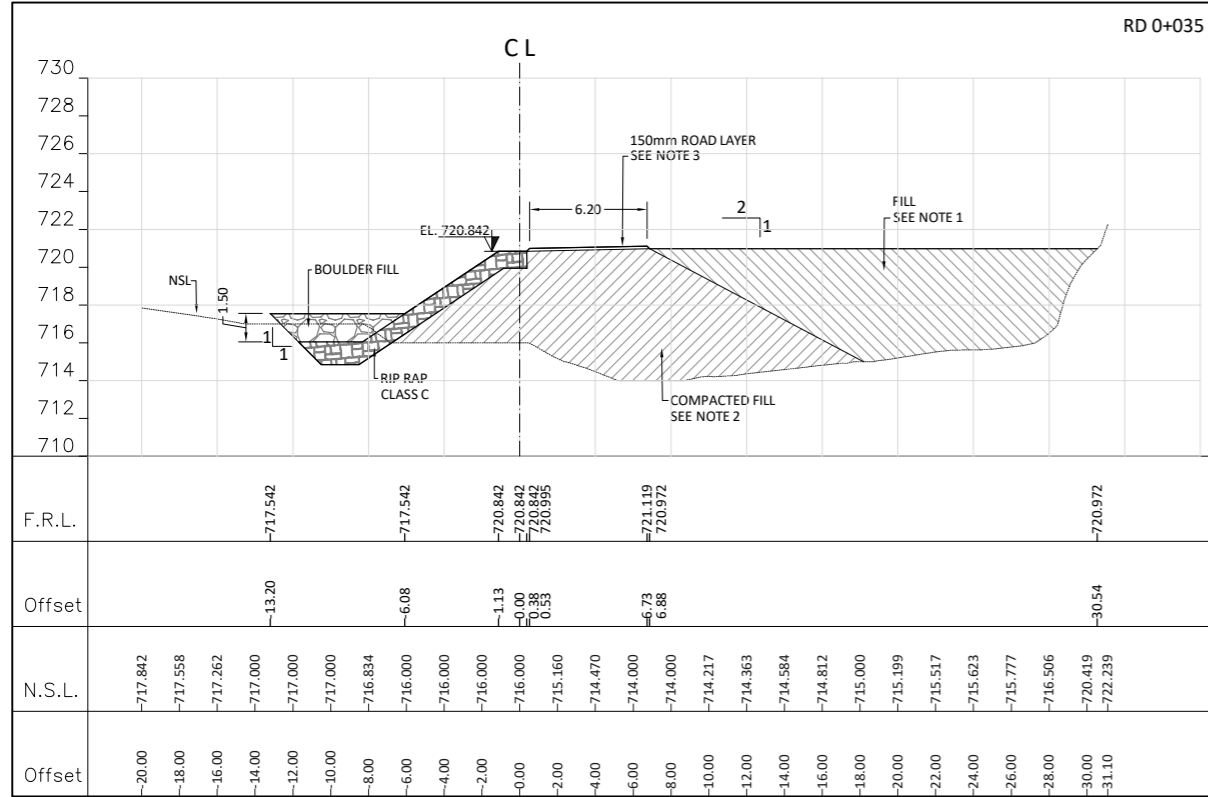

CLIENT	CONSULTANTS	PROJECT NAME	REFERENCES				SHEET CONTENTS
			DRAWN BY	AHMAD MAZHAR	DRAWING NO	PE-SEC-02	
		REHABILITATION AND RESTORATION OF RANOLIA HYDROPOWER PROJECT	DESIGNED BY	ZAHOOH AHMAD	REVISION		
			CHECKED BY	M. ISHAQ	DATE	APRIL, 2023	
			APPROVED BY	KHALIL HUSSAIN	SCALE	1:400	
			CONSTRUCTION OF PROTECTION EMBANKMENT U/S OF POWERHOUSE CROSS SECTIONS (SHEET 02 OF 06)				

- NOTES:
- 1: MATERIAL FROM EXCAVATION IN SHINGLE OR GRAVEL FORMATION NOT REQUIRING BLAST.
 - 2: MATERIAL FROM EXCAVATION IN SHINGLE OR GRAVEL FORMATION NOT REQUIRING BLAST AND COMPACTION BY MECHANICAL MEANS UPTO 90% MMDD.
 - 3: EMBANKMENT FORMATION IN ORDINARY SOIL AND COMPACTION BY MECHANICAL MEANS AT OMC TO 90% MMDD.

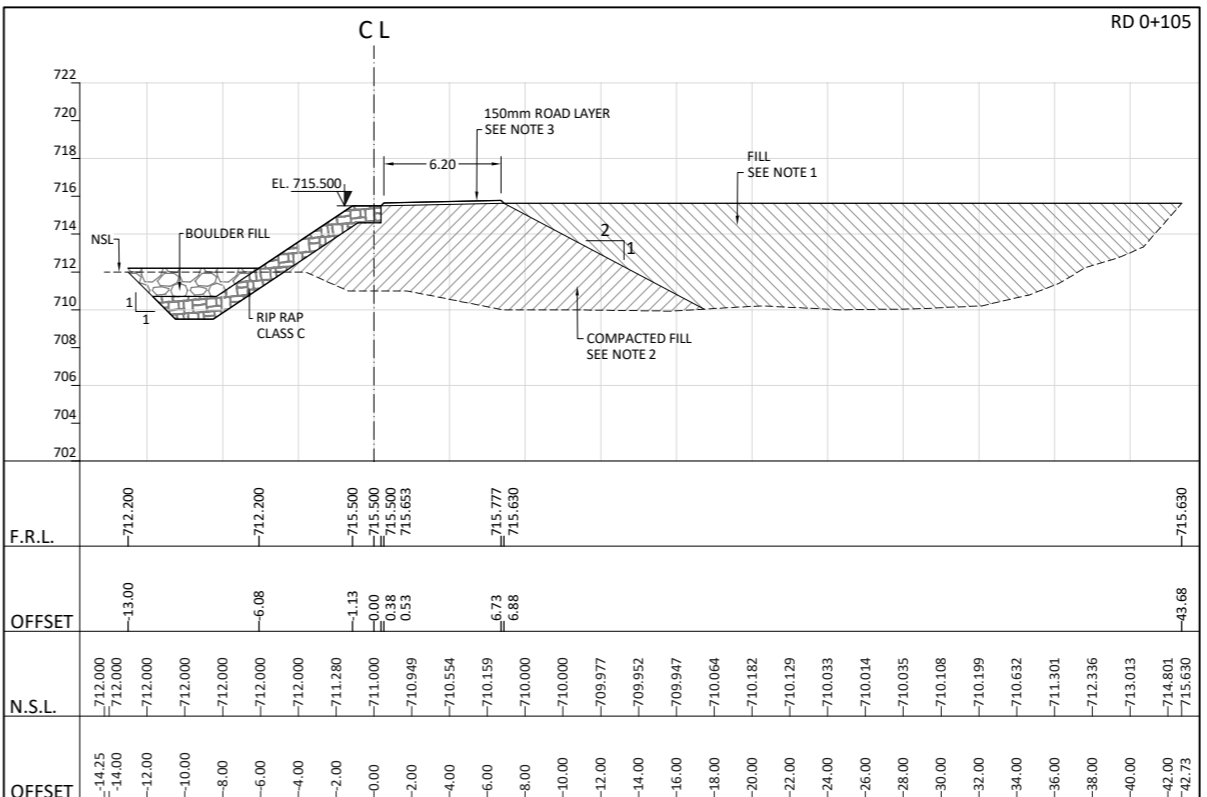
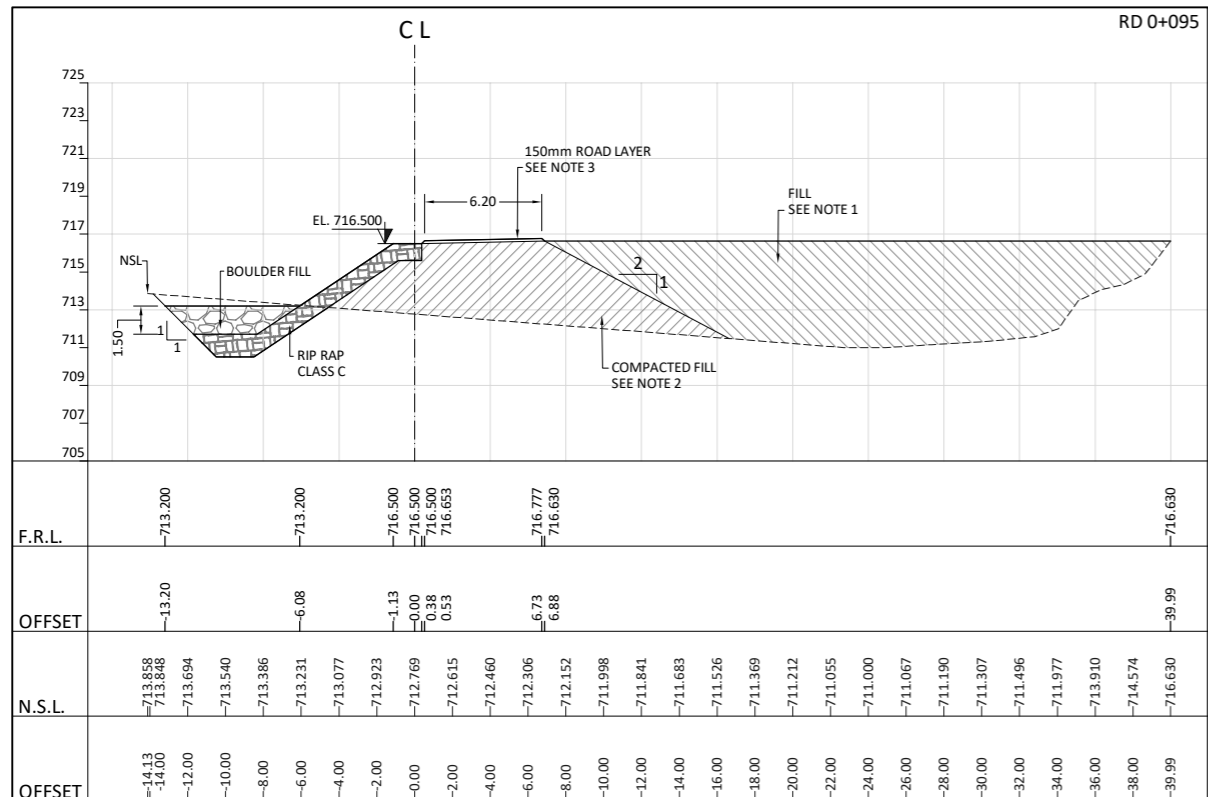
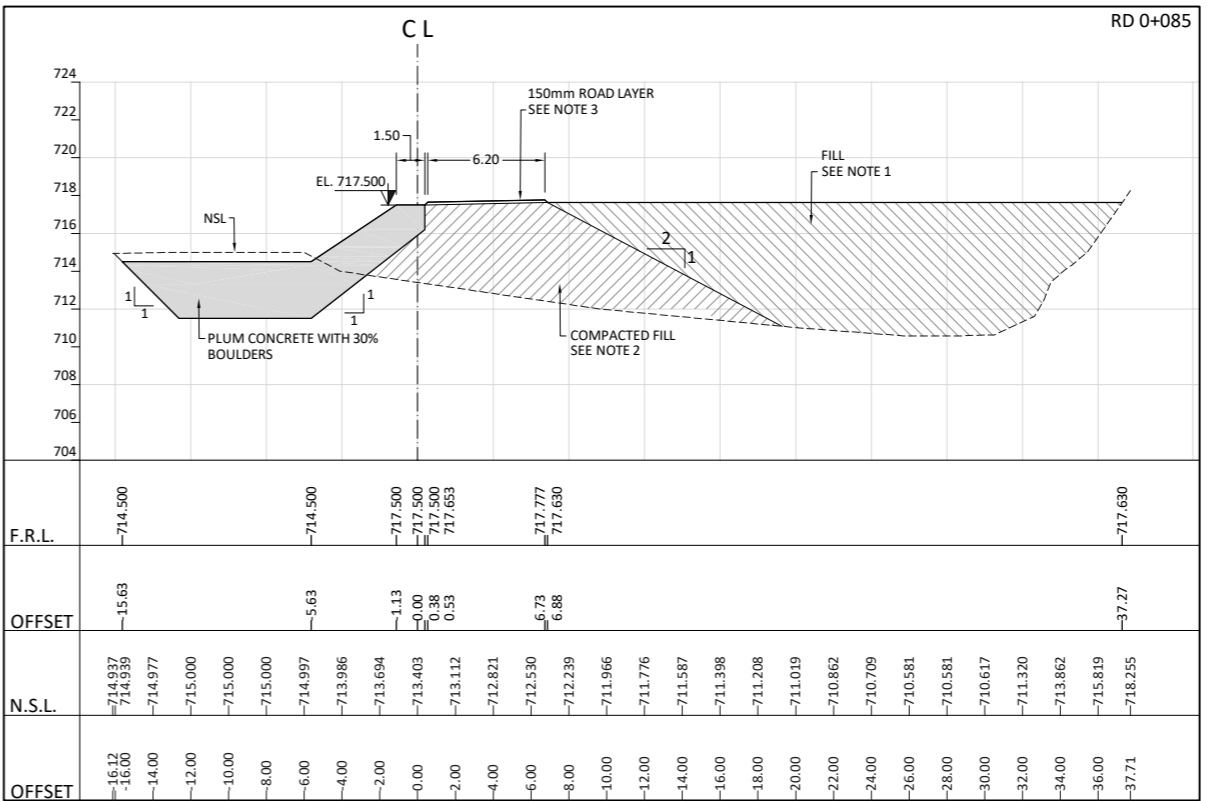
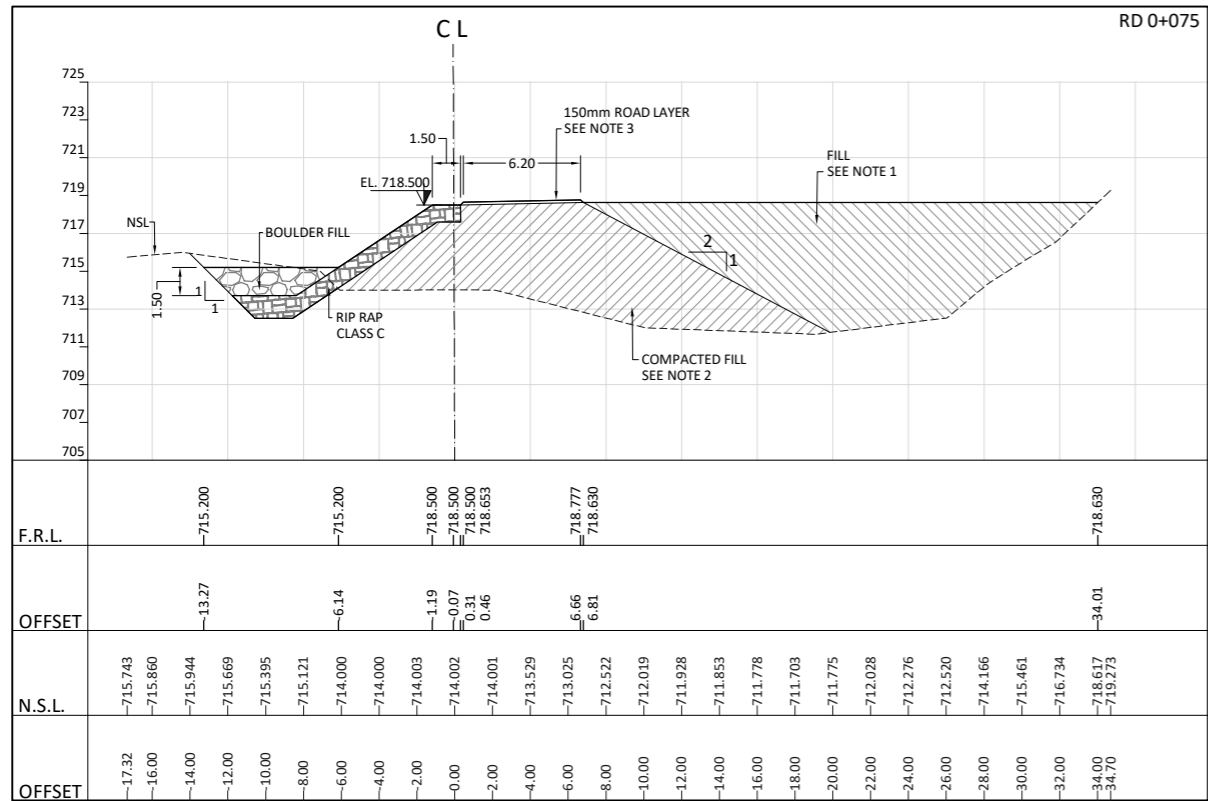

CLIENT	CONSULTANTS	PROJECT NAME	REFERENCES				SHEET CONTENTS
			DRAWN BY	AHMAD MAZHAR	DRAWING NO	PE-SEC-03	
		REHABILITATION AND RESTORATION OF RANOLIA HYDROPOWER PROJECT	DESIGNED BY	ZAHOOR AHMAD	REVISION		
			CHECKED BY	M. ISHAQ	DATE	APRIL, 2023	
			APPROVED BY	KHALIL HUSSAIN	SCALE	1:400	
			CONSTRUCTION OF PROTECTION EMBANKMENT U/S OF POWERHOUSE CROSS SECTIONS (SHEET 03 OF 06)				

- NOTES:
- 1: MATERIAL FROM EXCAVATION IN SHINGLE OR GRAVEL FORMATION NOT REQUIRING BLAST.
 - 2: MATERIAL FROM EXCAVATION IN SHINGLE OR GRAVEL FORMATION NOT REQUIRING BLAST AND COMPACTION BY MECHANICAL MEANS UPTO 90% MMDD.
 - 3: EMBANKMENT FORMATION IN ORDINARY SOIL AND COMPACTION BY MECHANICAL MEANS AT OMC TO 90% MMDD.

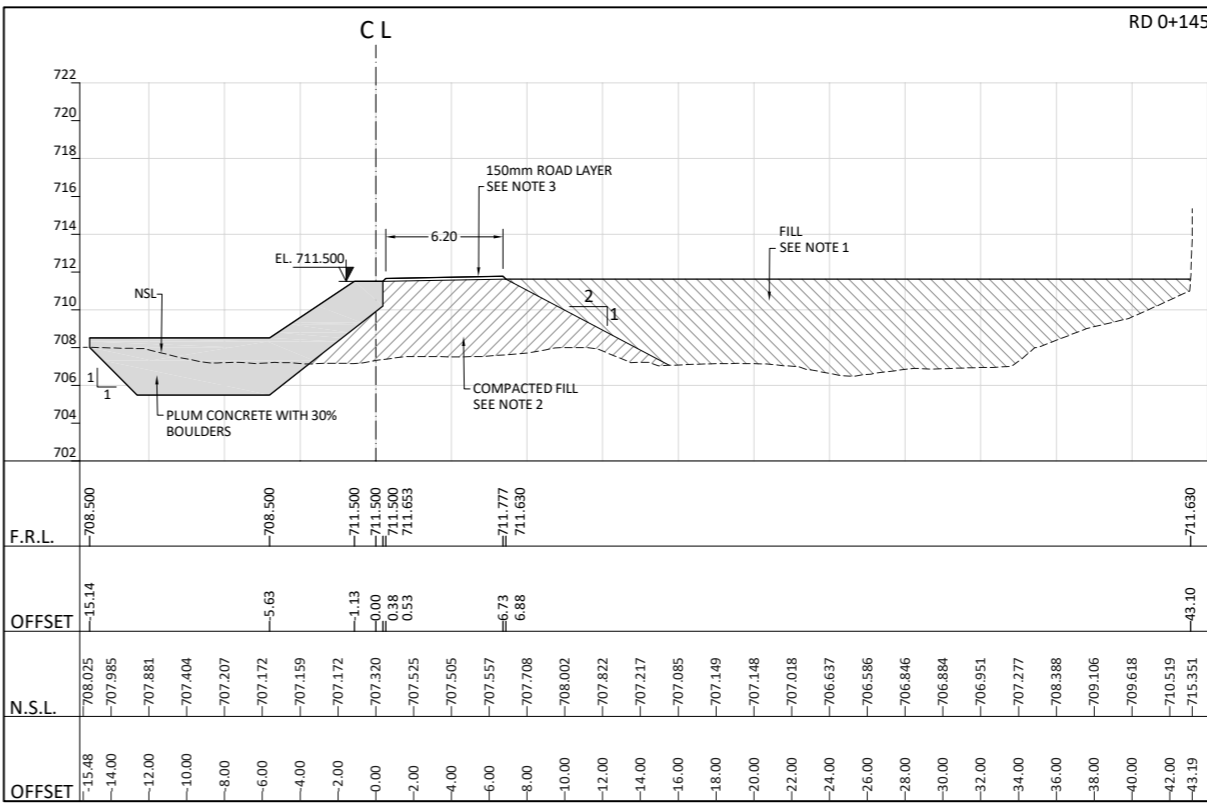
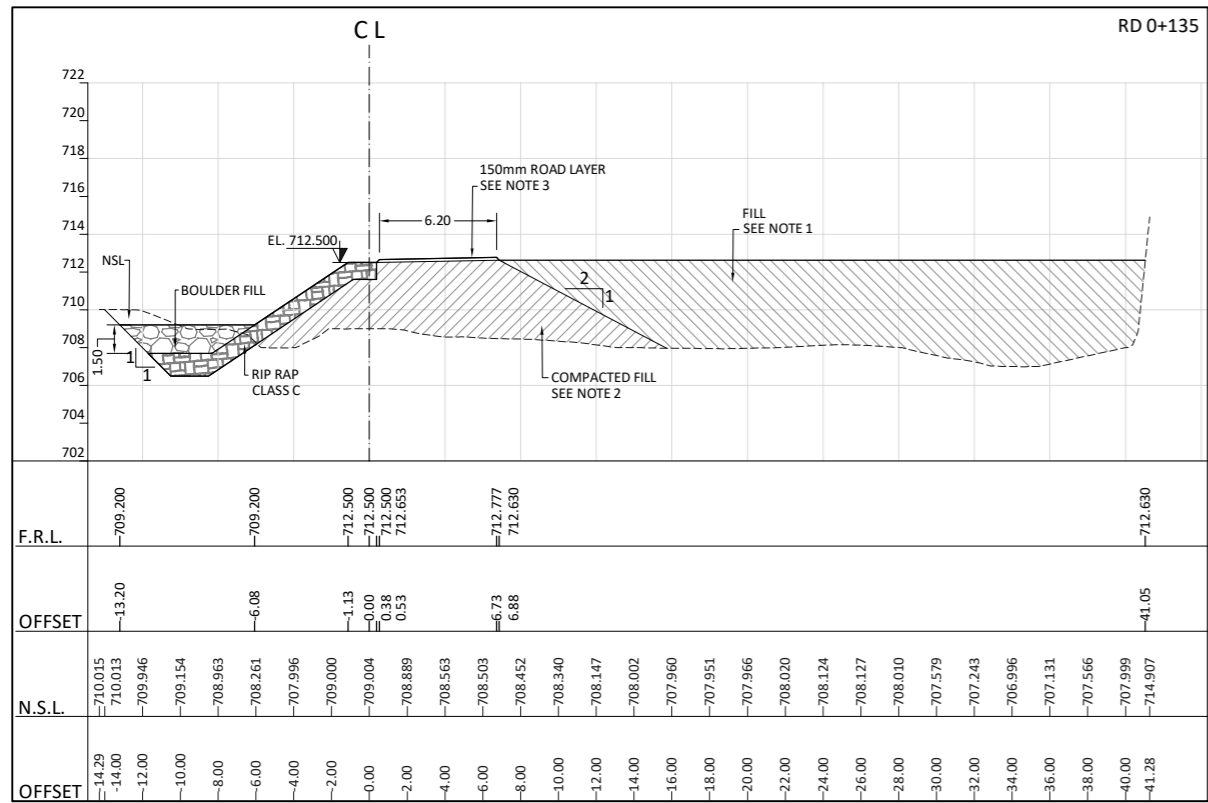
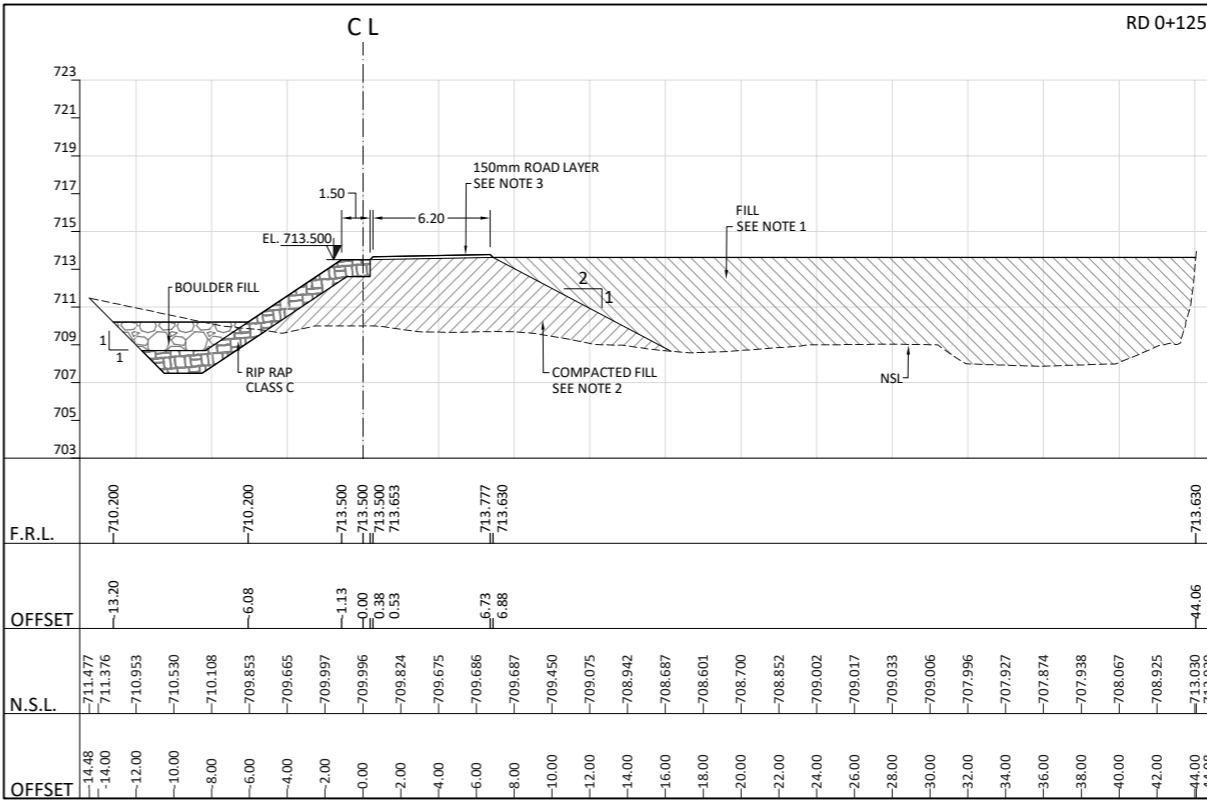
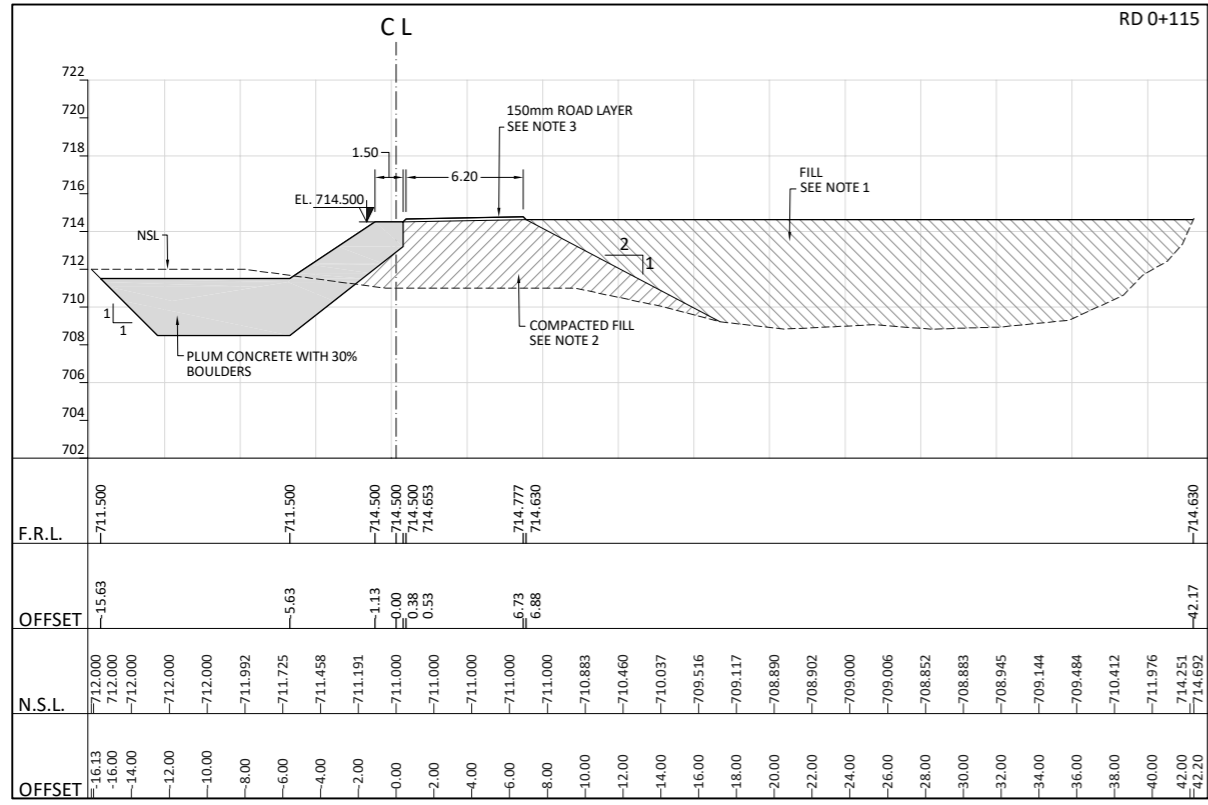

CLIENT	CONSULTANTS	PROJECT NAME	REFERENCES				SHEET CONTENTS
			DRAWN BY	AHMAD MAZHAR	DRAWING NO	PE-SEC-04	
		REHABILITATION AND RESTORATION OF RANOLIA HYDROPOWER PROJECT	DESIGNED BY	ZAHOOR AHMAD	REVISION		
			CHECKED BY	M. ISHAQ	DATE	APRIL, 2023	
			APPROVED BY	KHALIL HUSSAIN	SCALE	1:400	
			CONSTRUCTION OF PROTECTION EMBANKMENT U/S OF POWERHOUSE CROSS SECTIONS (SHEET 04 OF 06)				

NOTES:

- 1: MATERIAL FROM EXCAVATION IN SHINGLE OR GRAVEL FORMATION NOT REQUIRING BLAST.
- 2: MATERIAL FROM EXCAVATION IN SHINGLE OR GRAVEL FORMATION NOT REQUIRING BLAST AND COMPACTION BY MECHANICAL MEANS UPTO 90% MMDD.
- 3: EMBANKMENT FORMATION IN ORDINARY SOIL AND COMPACTION BY MECHANICAL MEANS AT OMC TO 90% MMDD.

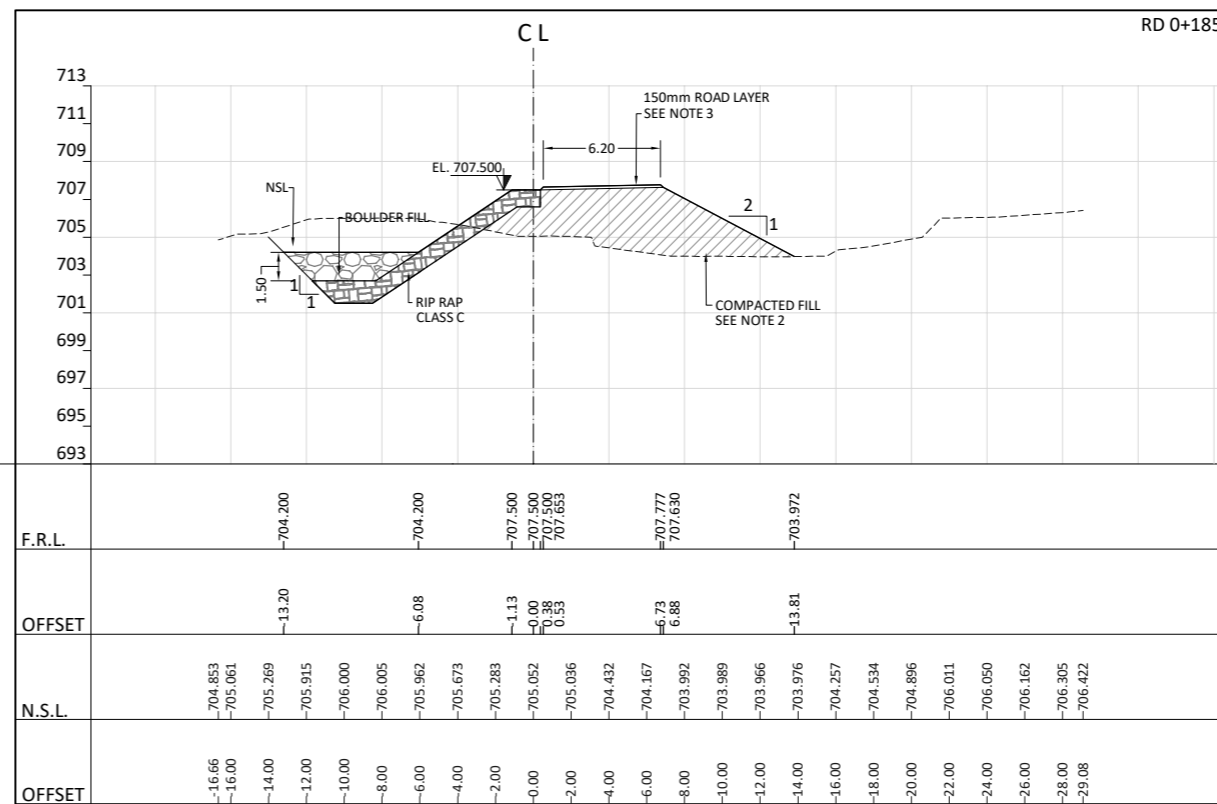
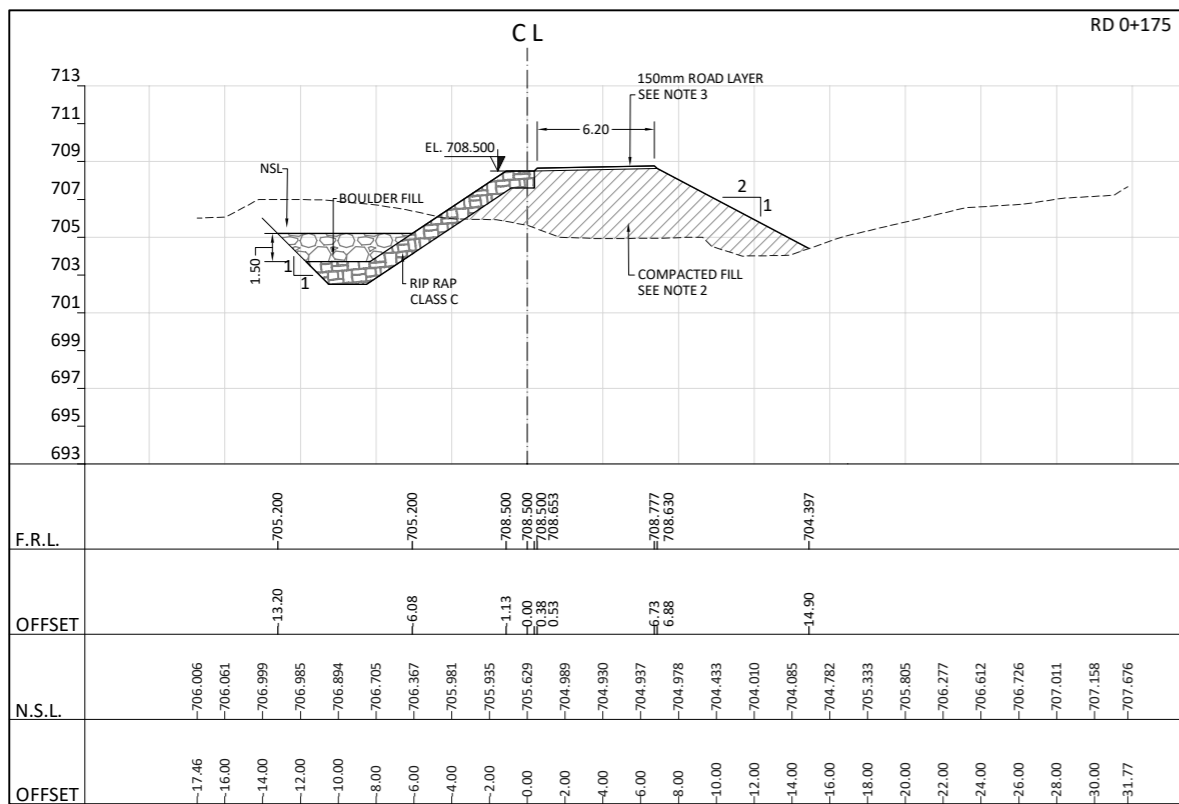
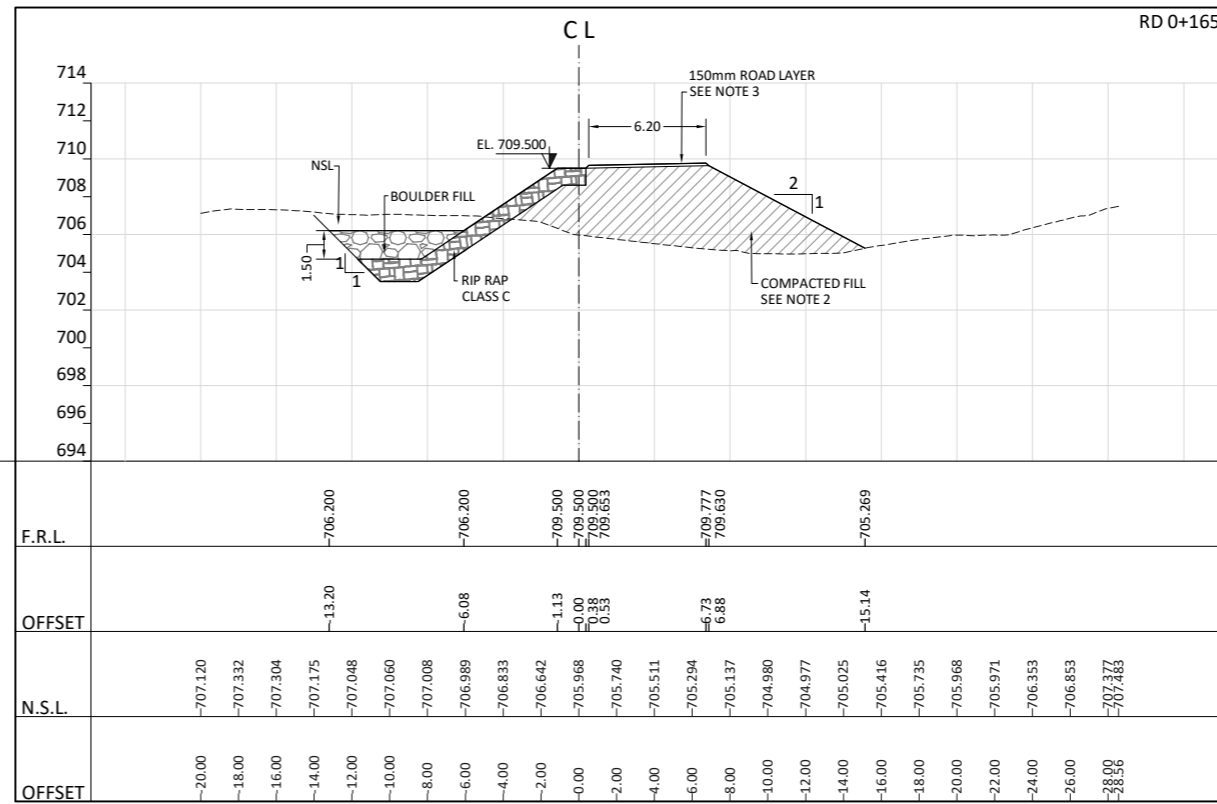
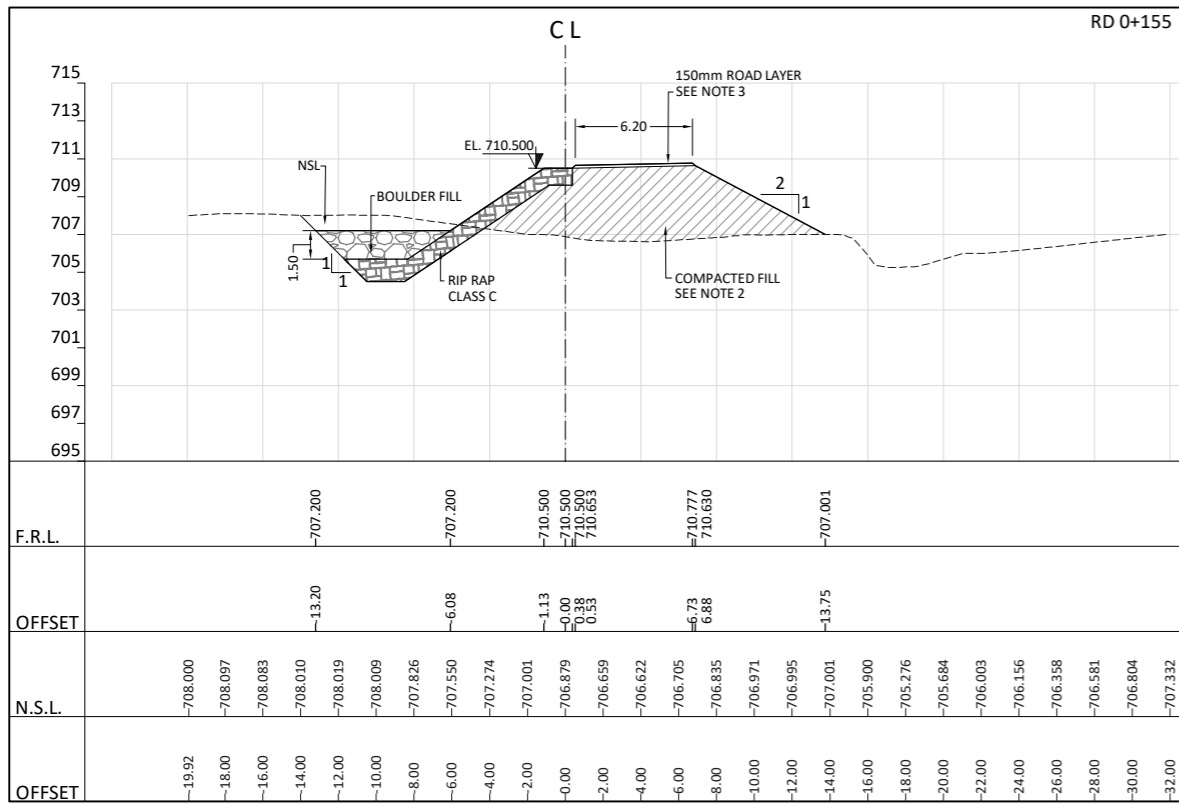

CLIENT	CONSULTANTS	PROJECT NAME	REFERENCES				SHEET CONTENTS
			DRAWN BY	AHMAD MAZHAR	DRAWING NO	PE-SEC-05	
		REHABILITATION AND RESTORATION OF RANOLIA HYDROPOWER PROJECT	DESIGNED BY	ZAHOOR AHMAD	REVISION		
			CHECKED BY	M. ISHAQ	DATE	APRIL, 2023	
			APPROVED BY	KHALIL HUSSAIN	SCALE	1:400	
			CONSTRUCTION OF PROTECTION EMBANKMENT U/S OF POWERHOUSE CROSS SECTIONS (SHEET 05 OF 06)				

- NOTES:
- 1: MATERIAL FROM EXCAVATION IN SHINGLE OR GRAVEL FORMATION NOT REQUIRING BLAST.
 - 2: MATERIAL FROM EXCAVATION IN SHINGLE OR GRAVEL FORMATION NOT REQUIRING BLAST AND COMPACTION BY MECHANICAL MEANS UPTO 90% MMDD.
 - 3: EMBANKMENT FORMATION IN ORDINARY SOIL AND COMPACTION BY MECHANICAL MEANS AT OMC TO 90% MMDD.

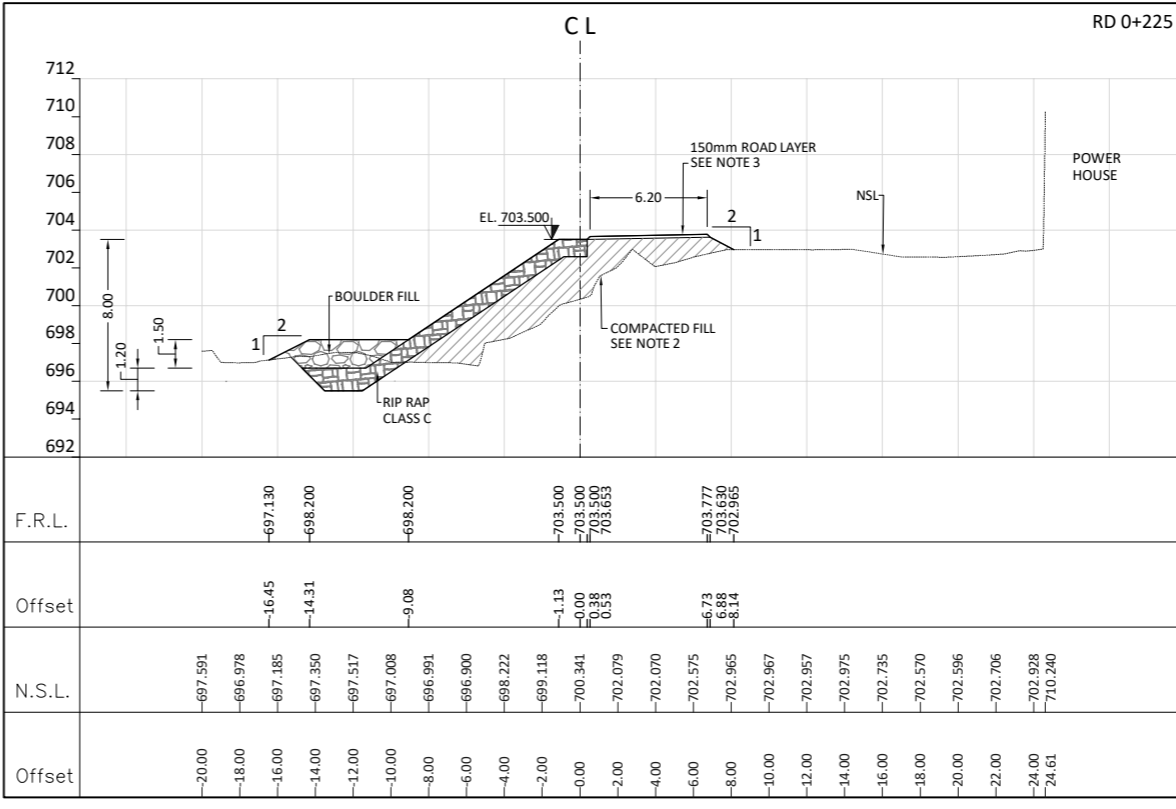
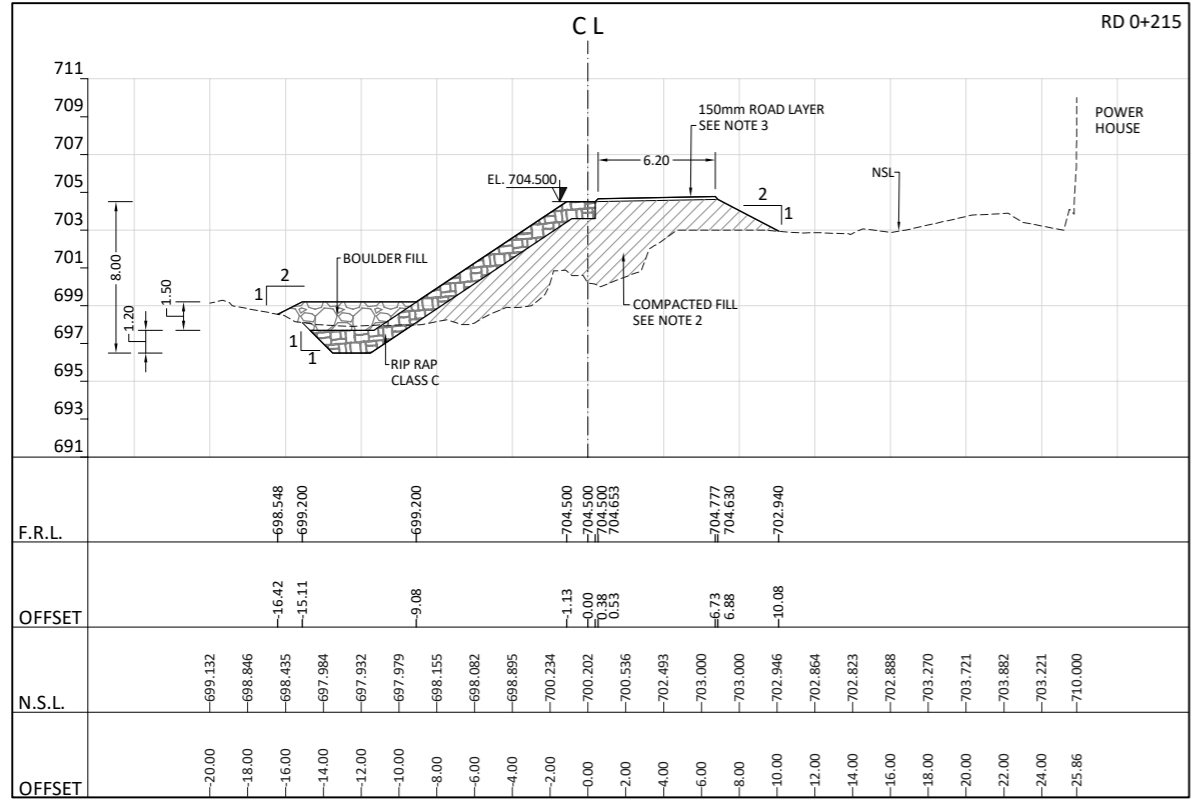
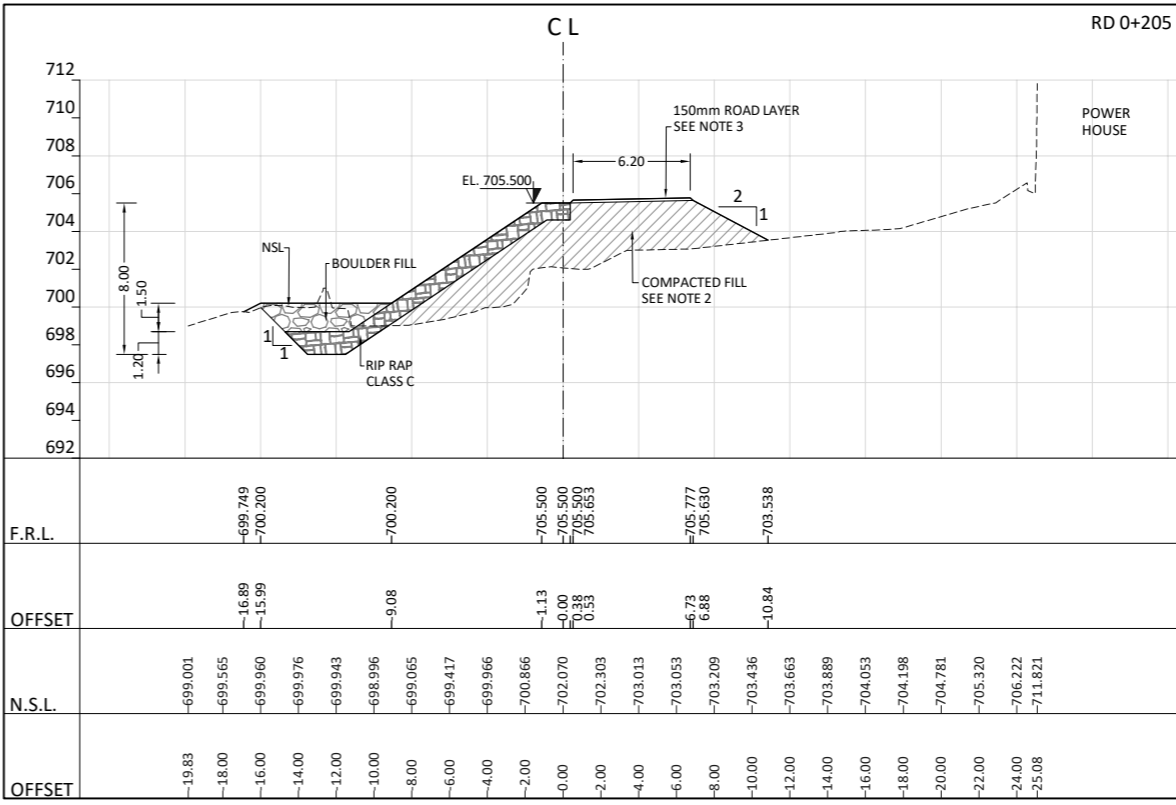
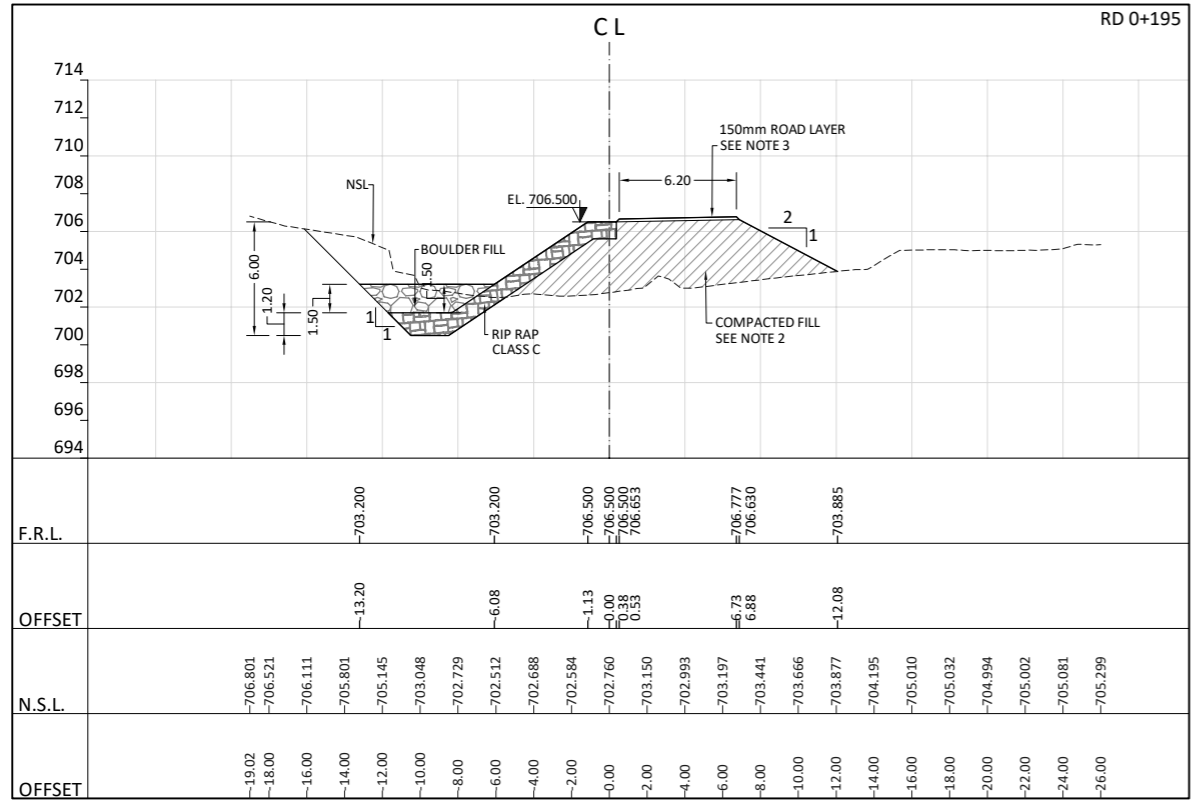

CLIENT	CONSULTANTS	PROJECT NAME	REFERENCES				SHEET CONTENTS
			DRAWN BY	AHMAD MAZHAR	DRAWING NO	PE-SEC-06	
		REHABILITATION AND RESTORATION OF RANOLIA HYDROPOWER PROJECT	DESIGNED BY	ZAHOOR AHMAD	REVISION		
			CHECKED BY	M. ISHAQ	DATE	APRIL, 2023	
			APPROVED BY	KHALIL HUSSAIN	SCALE	1:400	
			CONSTRUCTION OF PROTECTION EMBANKMENT U/S OF POWERHOUSE CROSS SECTIONS (SHEET 06 OF 06)				